

# V

## V8/V12 Manual 1.8 en

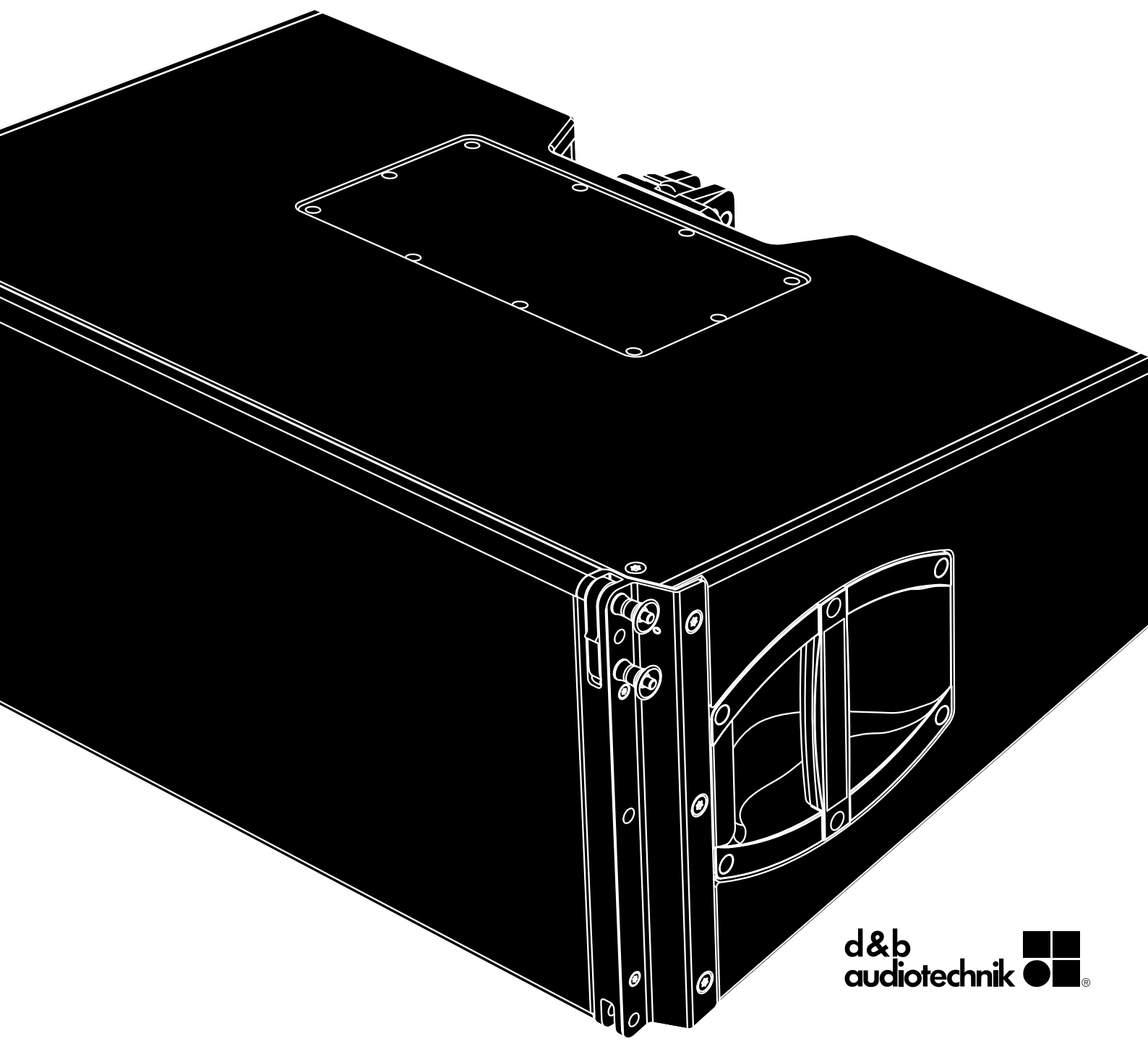

## **General information**

V8/V12 Manual

Version: 1.8 en, 09/2022, D2700.EN .01

Copyright © 2022 by d&b audiotechnik GmbH & Co. KG; all rights reserved.

**Keep this document with the product or in a safe place so that it is available for future reference.**

We recommend you to regularly check the d&b website for the latest version of this document.

When reselling this product, hand over this document to the new owner.

If you supply d&b products, please draw the attention of your customers to this document. Enclose the relevant documents with the systems. If you require additional documents for this purpose, you can order them from d&b.

d&b audiotechnik GmbH & Co. KG  
Eugen-Adolf-Str. 134, D-71522 Backnang, Germany  
T +49-7191-9669-0, F +49-7191-95 00 00

<b>1</b>	<b>Safety precautions</b> .....	<b>4</b>
1.1	d&b ArrayCalc.....	5
<b>2</b>	<b>V8/V12 loudspeaker</b> .....	<b>6</b>
2.1	Product description.....	6
2.2	Connections.....	7
2.3	Operation.....	7
2.3.1	Controller settings.....	8
2.4	Dispersion characteristics.....	9
2.5	Technical specifications.....	10
<b>3</b>	<b>Manufacturer's Declarations</b> .....	<b>11</b>
3.1	Conformity of loudspeakers.....	11
3.2	WEEE Declaration (Disposal).....	11

## **Potential risk of personal injury**

Never stand in the immediate vicinity of loudspeakers driven at a high level. Professional loudspeaker systems are capable of causing a sound pressure level detrimental to human health. Seemingly non-critical sound levels (from approx. 95 dB SPL) can cause hearing damage if people are exposed to it over a long period.

In order to prevent accidents when deploying loudspeakers on the ground or when flown, please take note of the following:

- When setting up the loudspeakers or loudspeaker stands, make sure they are standing on a firm surface. If you place several systems on top of one another, use straps to secure them against movement.
- Only use accessories which have been tested and approved by d&b for assembly and deployment. Pay attention to the correct application and maximum load capacity of the accessories as detailed in our specific "Mounting instructions" or in our "Rigging manuals".
- Ensure that all additional hardware, fixings and fasteners used for deployment are of an appropriate size and load safety factor. Pay attention to the manufacturers' instructions and to the relevant safety guidelines.
- Regularly check the loudspeaker housings and accessories for visible signs of wear and tear, and replace them when necessary.
- Regularly check all load bearing mounting devices.

## **Potential risk of material damage**

Loudspeakers produce a static magnetic field even if they are not connected or are not in use. Therefore make sure when erecting and transporting loudspeakers that they are nowhere near equipment and objects which may be impaired or damaged by an external magnetic field. Generally speaking, a distance of 0.5 m (1.5 ft) from magnetic data carriers (floppy disks, audio and video tapes, bank cards, etc.) is sufficient.

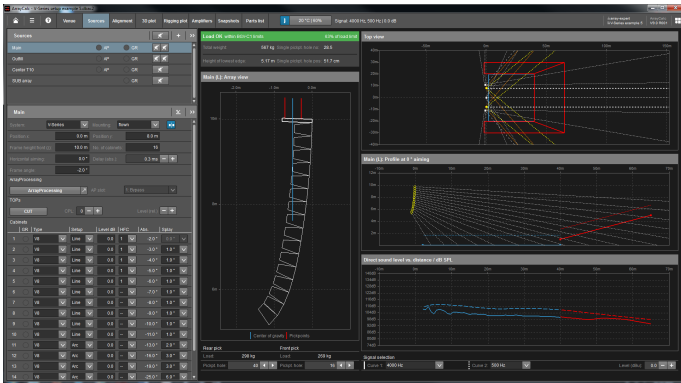

**d&b ArrayCalc**

### 1.1 d&b ArrayCalc

For both safety and acoustic reasons, d&b line arrays must be designed using the d&b ArrayCalc simulation software. The software is available as a native stand-alone application for both Microsoft Windows and Mac OS X operating systems and can be downloaded at [www.dbaudio.com](http://www.dbaudio.com).

Detailed information on how to use and operate ArrayCalc is provided by the Help system of the software. To access the Help system, press F1 or select the Help button (  ) from the ArrayCalc toolbar. This will launch the HelpViewer which provides an overview of the program as well as a search function and direct access to the related topics.

In addition, ArrayCalc will provide you with typical array configurations within the permitted load limits and will help you get familiar with the mechanical load conditions and limitations.

### d&b TI 385

Further information on line array design can be found in "TI 385 d&b Line array design, ArrayCalc". The TI is supplied with the software or can be downloaded from the d&b website at [www.dbaudio.com](http://www.dbaudio.com).

### d&b Seminar

We also recommend you to attend the regularly hosted d&b Line array training seminars. Further information regarding the d&b seminars and a seminar schedule can also be found on the d&b website at [www.dbaudio.com](http://www.dbaudio.com).

### d&b Video tutorials

In addition, d&b provides related video tutorials which can also be found on the d&b website at [www.dbaudio.com](http://www.dbaudio.com).

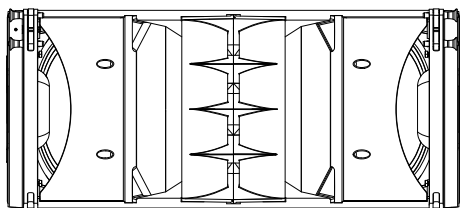

V8/V12 loudspeaker

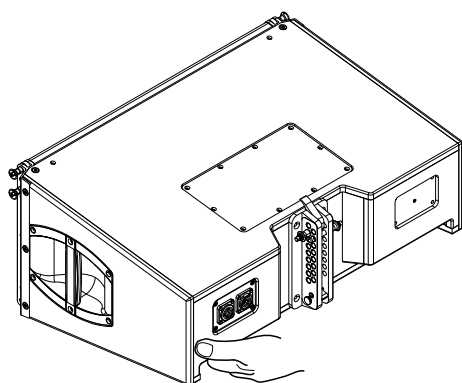

### 2.1 Product description

The V8 is a line array loudspeaker for medium to large-scale sound reinforcement. When the V Flying frame is used, up to 24 cabinets can be flown in vertical columns producing an 80° constant directivity dispersion pattern in the horizontal plane.

The V12 line array module is acoustically and mechanically compatible with the V8 and provides a 120° horizontal dispersion.

The V8 cabinet is a passive 3-way design housing 2 x 10" neodymium LF drivers, one horn-loaded 8" MF driver, two 1.4" exit HF compression drivers with 2.5" diaphragms mounted to a dedicated wave shaping device and a passive crossover network. The wave segments of each cabinet couple without gaps and sum up coherently. Splay angles between adjacent cabinets can be set in the range from 0° to 14° with a 1° resolution.

All components are arranged symmetrically around the center axis of the cabinet to produce a perfect symmetrical dispersion pattern. This setup allows for a crossover design with a well defined overlap of adjacent frequency bands resulting in a very consistent and accurate horizontal dispersion. Due to the dipolar arrangement of the low drivers broadband horizontal dispersion control is maintained down to approximately 250 Hz - an outstanding feature for a passive 3-way system.

The frequency response extends from 67 Hz to above 18 kHz.

The cabinet is constructed from marine plywood and has an impact and weather protected PCP (Polyurea Cabinet Protection) finish. The front of the loudspeaker cabinet is protected by a rigid metal grill backed by an acoustically transparent foam. Each side panel incorporates a handle while two additional recessed grips are provided at the rear bottom of the cabinet.

### V-Series rigging components and arrays

V-Series arrays may consist of a combination of V8 and V12 loudspeakers and/or V-SUB cardioid subwoofers.

Cabinets are mechanically connected using the rigging strands on both sides of the cabinet front and a central strand at the rear of the cabinet. All necessary rigging components are mounted to the cabinet and fold out or slide out when needed.

A detailed description of the V-Series rigging components is given in the V-Series Rigging manual which is provided with the V Flying frame.

A detailed description of planning and designing V-Series arrays is given in the technical information "TI 385 d&b Line array design, d&b ArrayCalc" which is also provided with the V Flying frame.

The d&b ArrayCalc simulation software can be downloaded from the d&b website at [www.dbaudio.com](http://www.dbaudio.com).

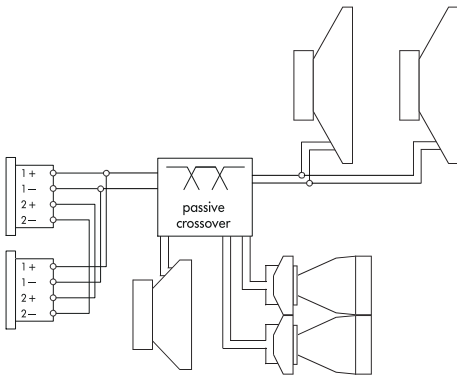

**Connector wiring**

## 2.2 Connections

The cabinets are fitted with a pair of 4-pin connectors. All four pins of both connectors are wired in parallel. The V8 and V12 loudspeakers use the pin assignments 1+/1-. Pins 2+/2- are designated to active subwoofers. Using the male connector as the input, the female connector allows for direct connection to a second cabinet.

The cabinets can be supplied with EP5 connectors as an option.

Pin equivalents of the connector options are listed in the table below.

<b>NL4 NLT4 F/M</b>	1+	1-	2+	2-	n.a.
<b>EP5</b>	1	2	3	4	5

## d&b LoadMatch

Starting with the D80 amplifier platform, the LoadMatch function enables the amplifier to electrically compensate for the properties of the loudspeaker cable used without the need for an additional sense wire. For applicable loudspeakers, LoadMatch is therefore independent of the connector type used.

## 2.3 Operation

### NOTICE!

Only operate d&b loudspeakers with a correctly configured d&b amplifier, otherwise there is a risk of damaging the loudspeaker components.

### Applicable d&b amplifiers:

D80/D40/D20/D12.

Application	Setup	Cabinets per channel
<b>V8</b>	V8 Line/V8 Arc	2
	V8 AP	1
<b>V12</b>	V12 Line/V12 Arc	2
	V12 AP	1

The applicable d&b amplifiers provide two setups ("Line" or "Arc") for the V8 and V12 loudspeakers. These are available in Dual Channel or Mix TOP/SUB mode.

### "Line" and "Arc" setups

The selection of "Line" or "Arc" depends on the curvature of the array. Both setups may be used within one array.

The "Line" setup is used for long throw array sections with three or more consecutive splay settings of 0°, 1° or 2°. Compared to the "Arc" setup, the mid/high range is reduced to compensate for the extended nearfield.

The "Arc" setup is intended for line array loudspeakers when used in curved array sections.

The transition from "Line" to "Arc" configuration within the array is made according to the splay progression but may allow for certain deviations due to the wiring of the cabinets in groups of up to two.

### AP setup

In connection with d&b ArrayProcessing (AP), the AP setup contains the AP data that is generated by the d&b ArrayCalc simulation software and transferred to the applicable amplifiers via the d&b Remote network (OCA/AES70) using R1.

As soon as the data has been sent to the amplifiers, the AP setup is automatically activated.

### 2.3.1 Controller settings

For acoustic adjustment the functions CUT, CPL and HFC can be selected.

#### CUT mode

Set to CUT, the low frequency level of the cabinets is reduced. The V8/V12 array is now configured for use with the d&b V-SUB or J-SUB subwoofers.

#### HFC function

Selecting the HFC (High Frequency Compensation) function compensates for the loss of high frequency energy due to air absorption when loudspeakers are used to cover far field listening positions.

The HFC function has two settings (HFC1 and HFC2) for different distances the cabinets need to cover. The settings should be used selectively; HFC1 for cabinets covering distances larger than 30 m (100 ft) and HFC2 for those covering distances larger than 60 m (200 ft).

The compensation is adjusted for a typical relative humidity of 40 %. With lower humidity the absorption by air increases therefore the distances where the respective HFC setting provides a correct equalization are shorter than indicated above.

Using the HFC function provides the correct sound balance between close and remote audience areas, whilst all amplifiers driving the array can be fed with the same signal.

#### CPL function

The CPL (Coupling) function compensates for coupling effects between the cabinets of an array. CPL begins gradually around 2 kHz, with the maximum attenuation below 100 Hz. As coupling effects increase with the length of the line array, the CPL function can be set to dB attenuation values between 0 and -9. With higher attenuation values the corner frequency of the filter shifts towards lower values.

Positive CPL values create an adjustable low frequency boost (0 to +5 dB) and can be set when the system is used in full range mode without subwoofers.

**Note:** Make sure that all cabinets within the line array are operated with the same CPL setting.

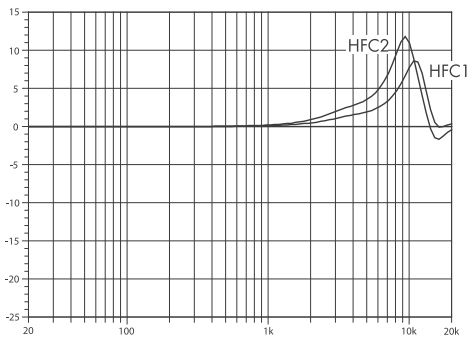

Frequency response correction of the HFC function

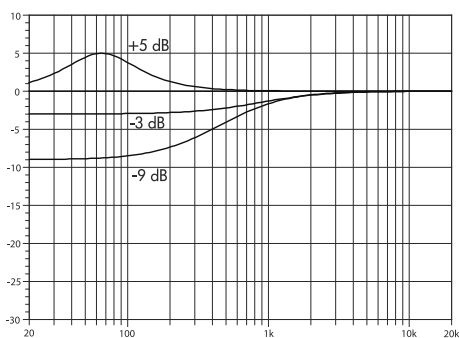

Frequency response correction of the CPL function



## 2.4 Dispersion characteristics

The graphs below show the horizontal dispersion angle over frequency plotted using lines of equal sound pressure (isobars) at -6 dB and -12 dB. The nominal dispersion is maintained above 600 Hz, while a useful horizontal dispersion control is achieved down to 250 Hz.

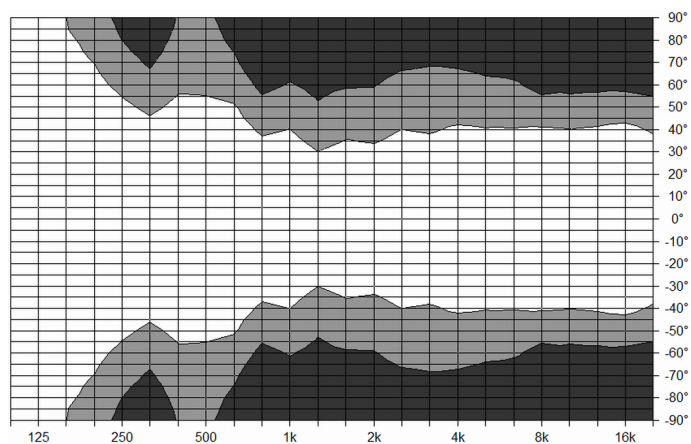

Isobar diagram V8 horizontal

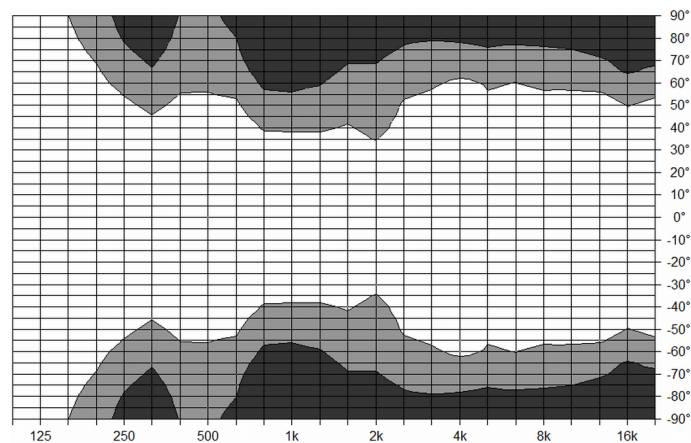

Isobar diagram V12 horizontal

## 2.5 Technical specifications

### System data

Frequency response (-5 dB standard)	67 Hz - 18 kHz
Frequency response (-5 dB CUT mode)	100 Hz - 18 kHz
Max. sound pressure (1 m, free field)	
with D20/D12	139 dB
with D80/D40	142 dB
	(SPLmax peak, pink noise test signal with crest factor of 4)

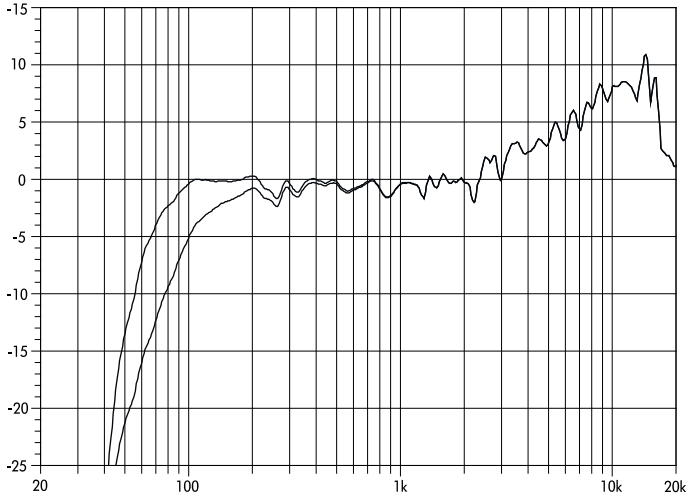

**V8 frequency response, standard and CUT modes**

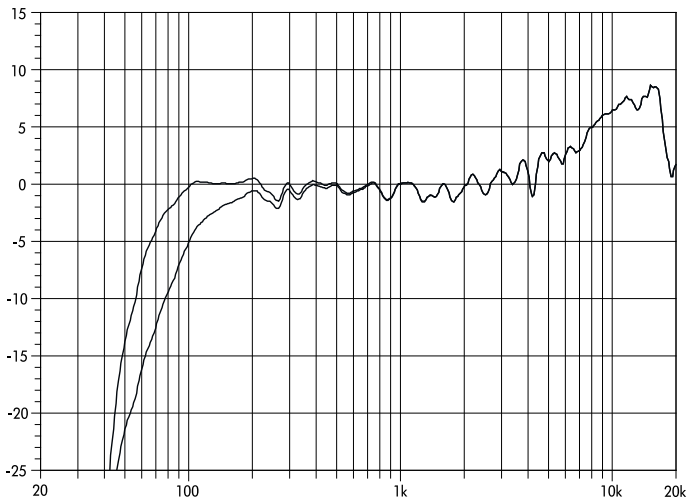

**V12 frequency response, standard and CUT modes**

### Loudspeaker data

Nominal impedance	8 ohms
Power handling capacity (RMS/peak 10 ms)	500/2000 W
Nominal dispersion angle (horizontal) V8	80°
Nominal dispersion angle (horizontal) V12	120°
Splay angle setting	0° ... 14°
	1° increment
Components	2 x 10" driver
	1 x 8" driver
	2 x 1.4" exit compression driver
	Passive crossover network
Connections	NLT4 F/M
	optional 2 x NLT4 M or 2 x EP5
Pin assignment	NLT4 F/M and NLT4 M: 1+/1-
	EP5: 1: + / 2: -
Weight	34 kg (75 lb)

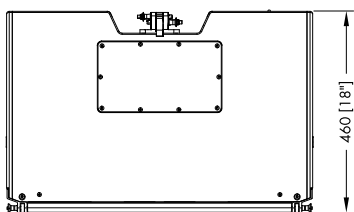
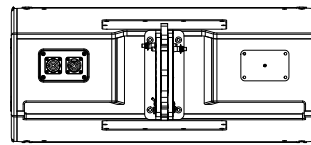
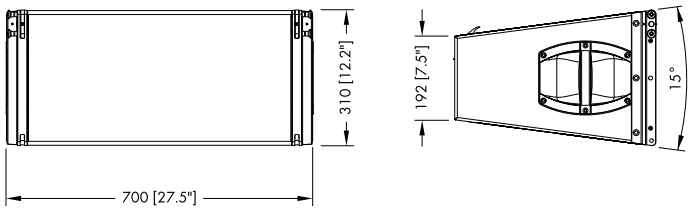

**V8/V12 cabinet dimensions in mm [inch]**

### 3.1 Conformity of loudspeakers

This declaration applies to:

**d&b Z0515 V8 loudspeaker**

**d&b Z0516 V12 loudspeaker**

by d&b audiotechnik GmbH & Co. KG.

All product variants are included, provided they correspond to the original technical version and have not been subject to any later design or electromechanical modifications.

We herewith declare that said products are in conformity with the provisions of the respective directives including all applicable amendments.

Detailed and applicable declarations are available on request and can be ordered from d&b or downloaded from the d&b website at [www.dbaudio.com](http://www.dbaudio.com).



### 3.2 WEEE Declaration (Disposal)

Electrical and electronic equipment must be disposed of separately from normal waste at the end of its operational lifetime.

Please dispose of this product according to the respective national regulations or contractual agreements. If there are any further questions concerning the disposal of this product, please contact d&b audiotechnik.

**WEEE-Reg.-Nr. DE: 13421928**

