



Type(s)
Project
Date
Notes

GENERAL INFORMATION

Over a decade of color research comes together in the fos/4 Panel. These fixtures were designed specifically for the studio and film industry, and take predictably nuanced color from reality to the camera to the screen.

With the fos/4 Panel available in three sizes and two arrays, you’ll never find yourself wishing for anything more. The fos/4 Panels are shockingly bright, but don’t sacrifice color quality. And with the addition of Deep Red LEDs, the Lustr X8 array pushes the boundaries of color rendering possibilities while the tunable Daylight HDR array gives new depth to your white light. The fos/4 series fixtures are made in the USA and backed by a 24/7/365 phone support guarantee – we’ll be there when you need us, regardless of time or day.

APPLICATIONS

- Television studios
- Location shoots
- Film sets

PRODUCT FEATURES

- Two array choices:
 - Lustr X8 full color array
 - Daylight HDR tunable white array
- Three sizes available
 - Small (8x24 in)
 - Medium (16x24 in)
 - Large (24x24 in)
- Intuitive UI with color picker
- Up to 62,000 lumens
- Select CCT between 1900–10450 K
- NFC configuration
- Multiverse® wireless control
- Standard 5/10 year LED fixture warranty

ORDERING INFORMATION

fos/4 Panel Lights

MODEL	DESCRIPTION	ETL PART NUMBER	CE PART NUMBER	
fos4PL8	fos/4 Panel, small (8x24 in), Lustr X8	7471A1000	7471A1200	
fos4PD8	fos/4 Panel, small (8x24 in), Daylight HDR	7471A1001	7471A1201	
fos4PL16	fos/4 Panel, medium (16x24 in), Lustr X8	7471A1010	7471A1210	
fos4PD16	fos/4 Panel, medium (16x24 in), Daylight HDR	7471A1011	7471A1211	
fos4PL24	fos/4 Panel, large (24x24 in), Lustr X8	7471A1020	7471A1220	
fos4PD24	fos/4 Panel, large (24x24 in), Daylight HDR	7471A1021	7471A1221	

Note: Fixtures finished standard in two-tone (black and studio gray). Fixtures ship with a yoke, standard diffusion, power cable and a junior (28 mm) pin.



PRODUCT SPECIFICATIONS

Source

LED details	Lumileds LUXEON® C
Max lumens (5600 K)	20,569/41,058/61,587
Lumens per watt (5600 K)	52.5/52.4/52.0
L70 rating (hours to 70% output)*	>54,000 hours

Color

Colors used	Lustr X8: Deep Red, Red, Amber, Lime, Green, Cyan, Blue, Indigo Daylight HDR: Deep Red, Red, Mint, Cyan, Blue, Indigo
Color temperature range	1900–10450 K
Calibrated array	Yes
Red shift	Yes (selectable)

Optical

Beam angle range	108° native with standard diffusion
Gate size	N/A
Aperture size	203x610 mm (8x24 in) 406x610 mm (16x24 in) 610x610 mm (24x24 in)
Pattern projection	No
Pattern size	N/A
Camera flicker control/Hz range	Flicker-free 20,000 Hz

Control

Input method	5-Pin XLR, Multiverse wireless and NFC
Protocols	DMX-512, RDM, City Theatrical Multiverse, NFC
Modes (footprint)	5 modes (1–12 channels)
RDM configuration	Yes
UI type	Full color display
Local control	Yes
Onboard presets	Yes (12)
Onboard sequences	Yes
Onboard effects	Yes (12)
Fixture-to-fixture control	Yes

Wireless

Band	2.400-2.480 GHz
Range	100 m indoors, 500 m line of sight (subject to conditions)
Max receivers	DMX: No limit RDM: Varies by transmitter used Multiverse SHoW Baby®: 585 Multiverse Transmitter: 5,000
Broadcast power	100 mW

Electrical

Voltage range	100–240 VAC 24–36 VDC (battery input for the small and medium only)*
Input method	AC via Neutrik TRUE1 TOP DC via 3-pin XLR Note: Small and medium models include power pass-thru.
Inrush (first half-cycle) (Small/Medium/Large)	120 V: 33.4/51.0/67.8 A 240 V: 57.0/94.4/155.0 A
Fixtures per circuit on standard R20 breaker (Small/Medium/Large)*	4/2/1 Note: TRUE1 connector rated for 20 A (120 V/60 Hz) and 16 A (240 V/50 Hz).
Wattage (Typical) (Small/Medium/Large)	120 V: 475/955/1,475 W 230 V: 465/935/1,430 W
Current draw (Small/Medium/Large)	120 V: 4.0/8.2/12.4 A 230 V: 2.1/4.2/6.3 A
*Note	The maximum fixture output may be reduced when powered by battery.

*All measurements are for 120 V, 60 Hz. Results may vary in different regions.

Thermal

Ambient operating temp	0°–40° C (32°–104° F)
Fan (controllable)	Yes (yes)
Drop compensation	Yes
dB range	22.4/24.5/26.5 dBA
BTUs/hour (120 V)	1,620/3,257/5,030

Physical

Materials	Cast and extruded aluminum
Color options	Two-tone (black and studio gray)
Mounting options	Yoke or Gripail (M6 standard T-nut)
IP rating	IP20
Weight	Small: 14.5 kg (32 lb) Medium: 25.4 kg (56 lb) Large: 35.8 kg (79 lb)
Included accessories	Yoke, standard diffusion, laminated quick card, power cable and junior (28 mm) pin

Warranty

Fixture	5 years
LED array	10 years

Regulatory and Compliance

Approved regulatory standards	cETLus Listed CE Compliant
-------------------------------	-------------------------------

Note: All LED sources experience some lessening of light output and some color shift over time. LED output will vary with thermal conditions. In individual situations, LEDs will be used for different durations and levels. This can eventually lead to minor alterations in color performance, necessitating slight adjustments to presets, cues or programs.

PRODUCT FEATURES



DEEP RED
Providing the most nuanced color control from the deepest ends of the spectrum.



WIRELESS DMX/RDM AND NFC
Configure and control your fixture from your phone or tablet, or use DMX/RDM with Multiverse from your console.



GRIPRAIL
Mount your fixture or attach numerous accessories to this practical design feature of the fos/4 Panel.

COLOR METRIC INFORMATION

Additional Color Metrics

	LUSTR 3200 K	LUSTR 4500 K	LUSTR 5600 K	DAYLIGHT 3200 K	DAYLIGHT 4500 K	DAYLIGHT 5600 K
CRI Ra	98	97	96	83	89	93
TLCI	99	99	99	87	94	95
SSI	84	77	72	77	73	71

fos/4 PANEL LUSTR X8 3200 K TM-30-18

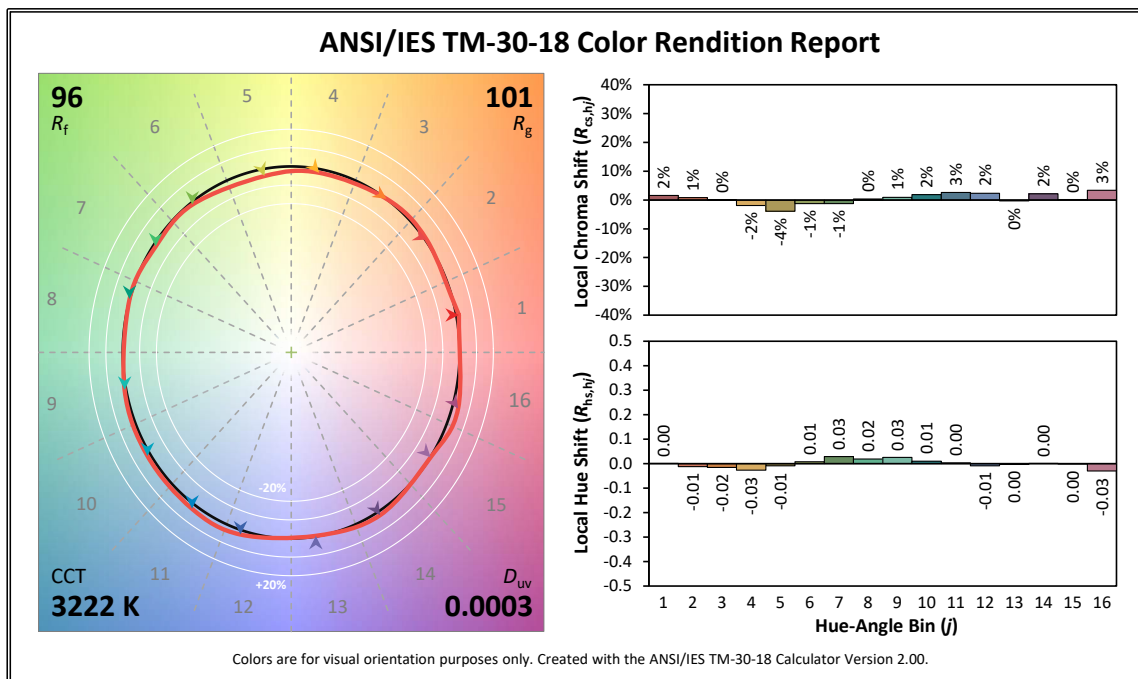

COLOR METRIC INFORMATION

fos/4 PANEL LUSTR X8 4500 K TM-30-18

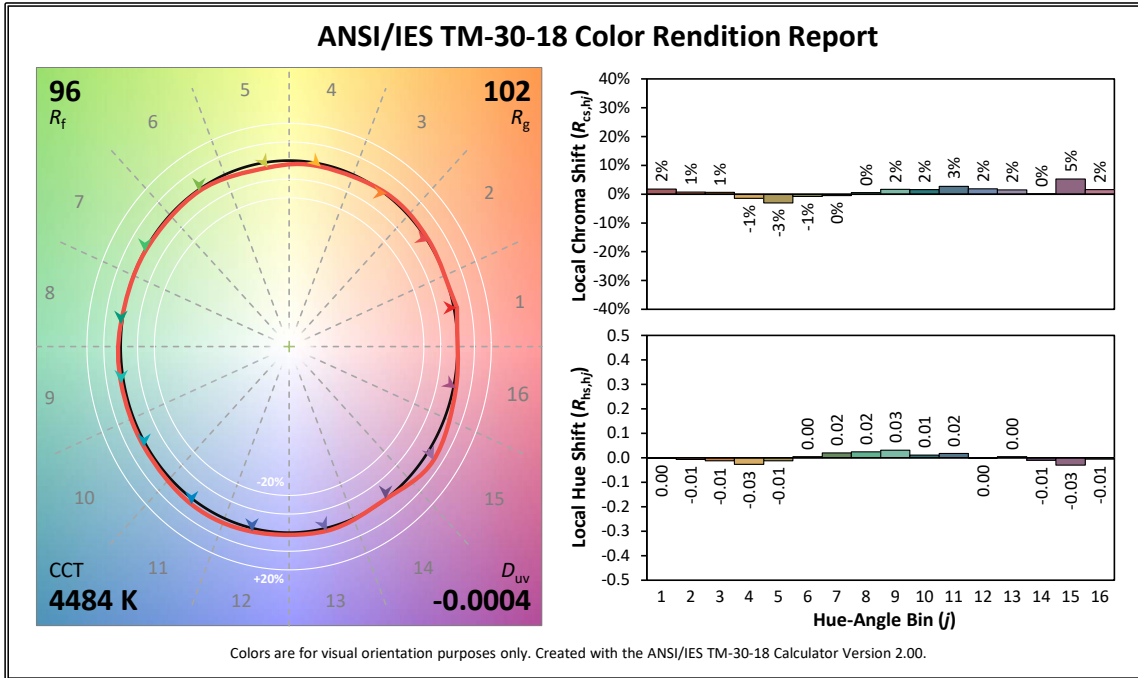

fos/4 PANEL LUSTR X8 5600 K TM-30-18

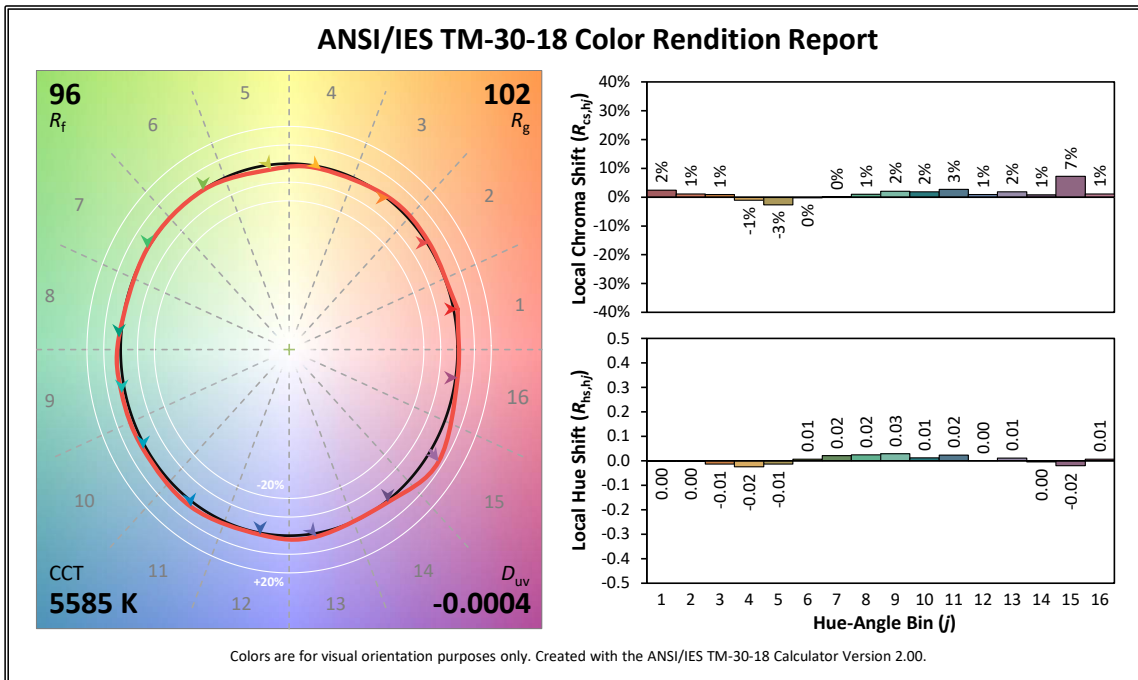

COLOR METRIC INFORMATION

fos/4 PANEL DAYLIGHT HDR 3200 K TM-30-18

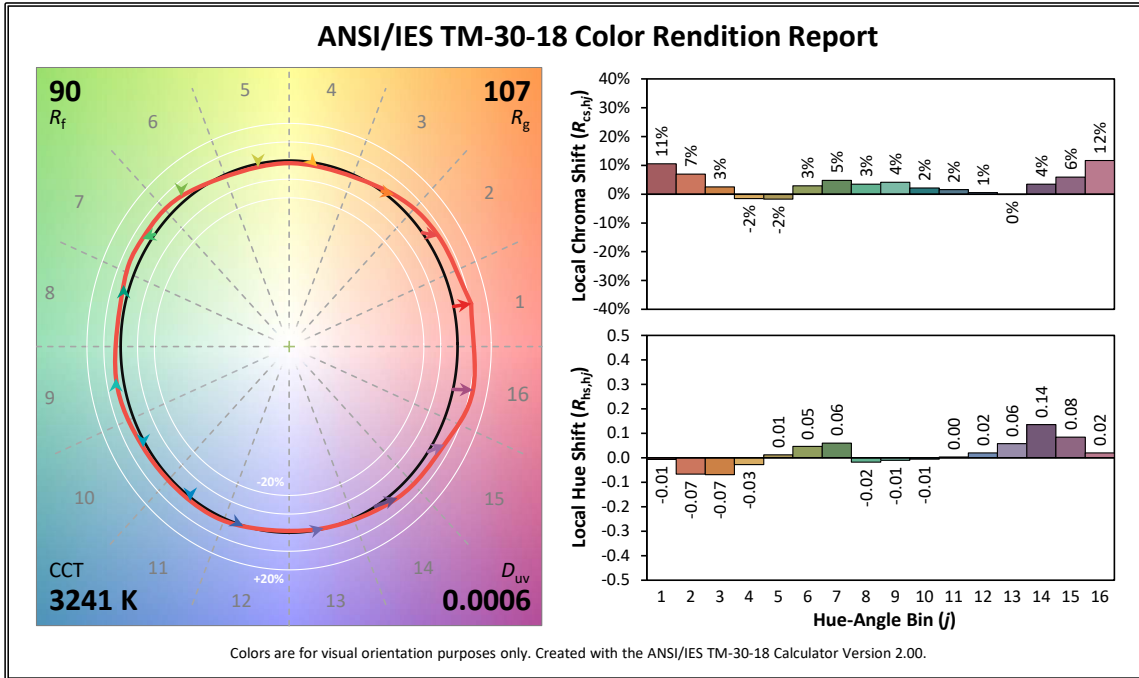

fos/4 PANEL DAYLIGHT HDR 4500 K TM-30-18

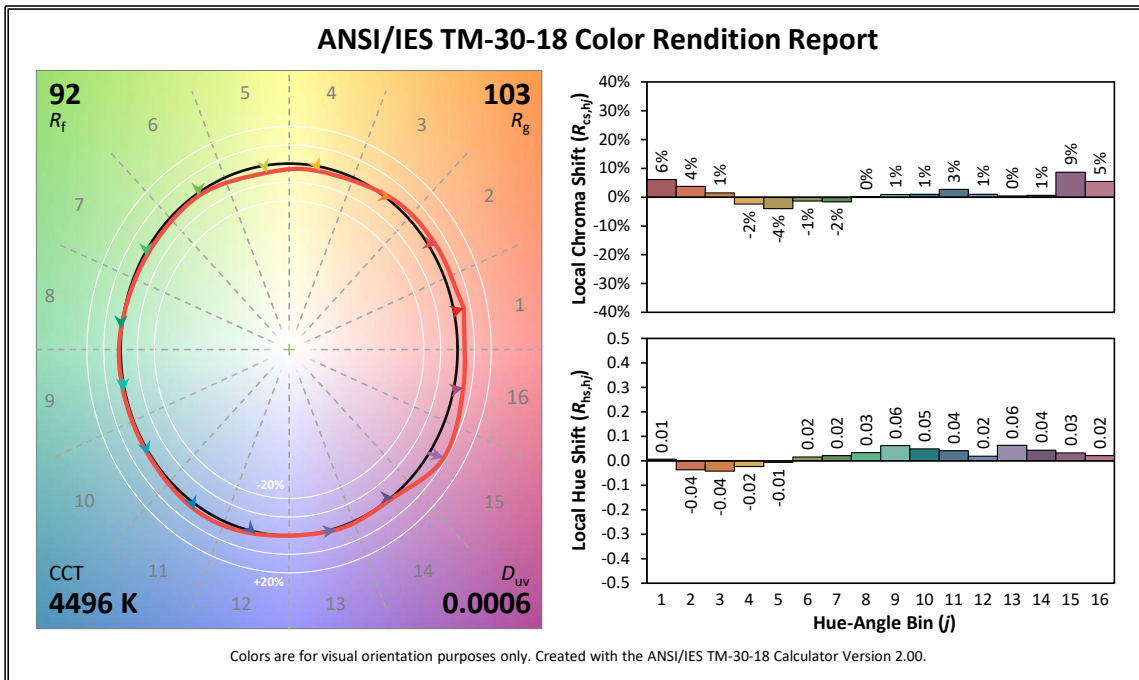

COLOR METRIC INFORMATION

fos/4 PANEL DAYLIGHT HDR 5600 K TM-30-18

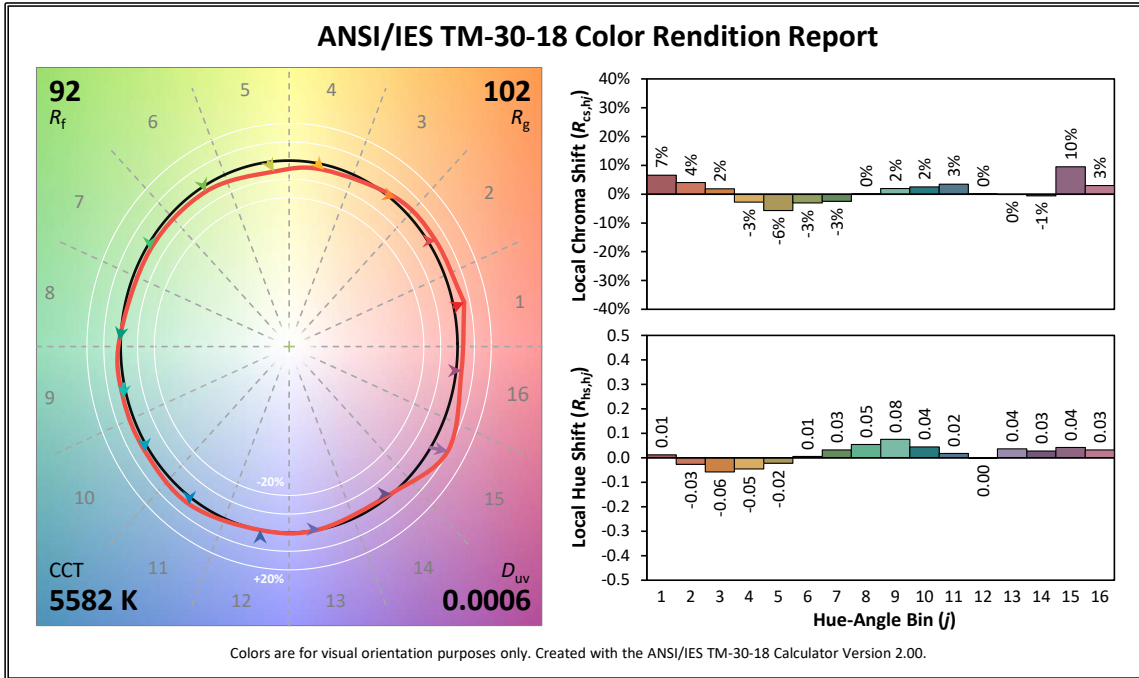

PHOTOMETRY INFORMATION

fos/4 Panel Small Lustr X8 (PL8) - Standard Diffuser

Mode	Candela	Total Lumens	Power Consumption	Lumens Per Watt
3200 K - Brightest	5,020	13,504	284	47.5
3200 K - Hybrid	3,926	10,560	*	*
3200 K - Spectral	2,831	7,616	*	*
4500 K - Brightest	5,961	16,036	350	45.8
4500 K - Hybrid	5,054	13,595	*	*
4500 K - Spectral	4,149	11,161	*	*
5600 K - Brightest	6,433	17,304	391	44.3
5600 K - Hybrid	5,531	14,878	*	*
5600 K - Spectral	4,631	12,459	*	*

Illuminance (footcandles)

Mode	1 m	2 m	3 m
3200 K - Brightest	465	121	54
3200 K - Hybrid	364	95	42
3200 K - Spectral	262	68	30
4500 K - Brightest	552	144	64
4500 K - Hybrid	468	122	54
4500 K - Spectral	384	100	45
5600 K - Brightest	596	155	69
5600 K - Hybrid	512	133	59
5600 K - Spectral	429	112	50

To determine center beam illumination in footcandles at large distances, divide candela by the throw distance squared. For field diameter at large distances, multiply distance by 9.021. For beam diameter at large distances, multiply by 2.654. Metric conversions: For feet, multiply meters by 3.2808. For lux, multiply footcandles by 10.76. *Note: Wattage for modes other than Brightest can vary from fixture to fixture based on LEDs but will not exceed Brightest.

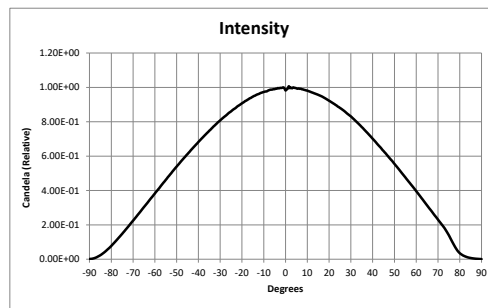

fos/4 Panel Small Lustr X8 (PL8) - Light Diffuser

Mode	Candela	Total Lumens	Power Consumption	Lumens Per Watt
3200 K - Brightest	5,172	13,471	284	47.4
3200 K - Hybrid	4,045	10,534	*	*
3200 K - Spectral	2,917	7,598	*	*
4500 K - Brightest	6,142	15,997	350	45.7
4500 K - Hybrid	5,207	13,562	*	*
4500 K - Spectral	4,275	11,134	*	*
5600 K - Brightest	6,627	17,262	391	44.1
5600 K - Hybrid	5,698	14,842	*	*
5600 K - Spectral	4,772	12,428	*	*

Illuminance (footcandles)

Mode	1 m	2 m	3 m
3200 K - Brightest	482	128	57
3200 K - Hybrid	377	100	44
3200 K - Spectral	272	72	32
4500 K - Brightest	572	152	67
4500 K - Hybrid	485	129	57
4500 K - Spectral	398	106	47
5600 K - Brightest	617	164	73
5600 K - Hybrid	531	141	63
5600 K - Spectral	444	118	52

To determine center beam illumination in footcandles at large distances, divide candela by the throw distance squared. For field diameter at large distances, multiply distance by 8.663. For beam diameter at large distances, multiply by 2.560. Metric conversions: For feet, multiply meters by 3.2808. For lux, multiply footcandles by 10.76. *Note: Wattage for modes other than Brightest can vary from fixture to fixture based on LEDs but will not exceed Brightest.

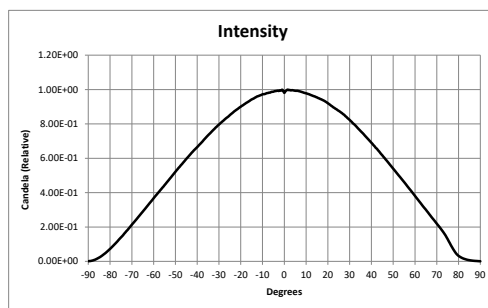

PHOTOMETRY INFORMATION

fos/4 Panel Small Lustr X8 (PL8) - Heavy Diffuser

Mode	Candela	Total Lumens	Power Consumption	Lumens Per Watt
3200 K - Brightest	4,468	12,056	284	42.5
3200 K - Hybrid	3,494	9,428	*	*
3200 K - Spectral	2,520	6,800	*	*
4500 K - Brightest	5,306	14,317	350	40.9
4500 K - Hybrid	4,498	12,138	*	*
4500 K - Spectral	3,693	9,964	*	*
5600 K - Brightest	5,725	15,448	391	39.5
5600 K - Hybrid	4,923	13,283	*	*
5600 K - Spectral	4,122	11,123	*	*

Illuminance (footcandles)

Mode	1 m	2 m	3 m
3200 K - Brightest	401	106	47
3200 K - Hybrid	314	83	37
3200 K - Spectral	226	60	27
4500 K - Brightest	476	126	56
4500 K - Hybrid	404	107	48
4500 K - Spectral	332	88	39
5600 K - Brightest	514	136	61
5600 K - Hybrid	442	117	52
5600 K - Spectral	370	98	44

To determine center beam illumination in footcandles at large distances, divide candela by the throw distance squared. For field diameter at large distances, multiply distance by 9.021. For beam diameter at large distances, multiply by 2.753. Metric conversions: For feet, multiply meters by 3.2808. For lux, multiply footcandles by 10.76. *Note: Wattage for modes other than Brightest can vary from fixture to fixture based on LEDs but will not exceed Brightest.

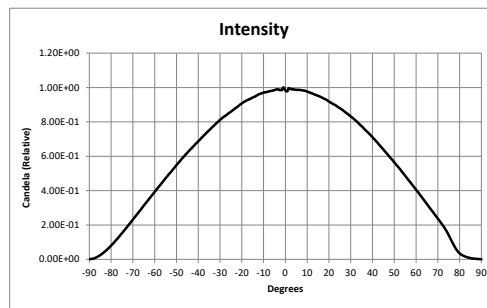

fos/4 Panel Small Lustr X8 (PL8) - Intensifier Diffuser

Mode	Candela	Total Lumens	Power Consumption	Lumens Per Watt
3200 K - Brightest	8,577	7,841	284	27.6
3200 K - Hybrid	6,707	6,132	*	*
3200 K - Spectral	4,837	4,422	*	*
4500 K - Brightest	10,185	9,311	350	26.6
4500 K - Hybrid	8,635	7,894	*	*
4500 K - Spectral	7,089	6,481	*	*
5600 K - Brightest	10,990	10,047	391	25.7
5600 K - Hybrid	9,450	8,639	*	*
5600 K - Spectral	6,175	5,646	*	*

Illuminance (footcandles)

Mode	1 m	2 m	3 m
3200 K - Brightest	724	199	88
3200 K - Hybrid	566	155	69
3200 K - Spectral	408	112	50
4500 K - Brightest	859	236	105
4500 K - Hybrid	728	200	89
4500 K - Spectral	598	164	73
5600 K - Brightest	927	254	113
5600 K - Hybrid	797	219	97
5600 K - Spectral	668	183	81

To determine center beam illumination in footcandles at large distances, divide candela by the throw distance squared. For field diameter at large distances, multiply distance by 9.021. For beam diameter at large distances, multiply by 2.753. Metric conversions: For feet, multiply meters by 3.2808. For lux, multiply footcandles by 10.76. *Note: Wattage for modes other than Brightest can vary from fixture to fixture based on LEDs but will not exceed Brightest.

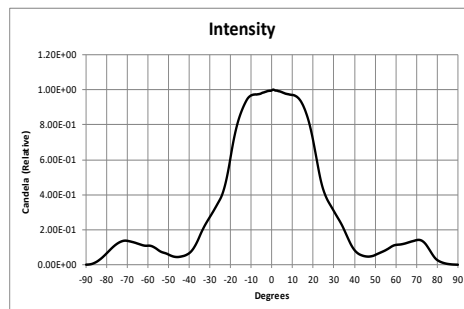

PHOTOMETRY INFORMATION

fos/4 Panel Medium Lustr X8 (PL16) - Standard Diffuser

Mode	Candela	Total Lumens	Power Consumption	Lumens Per Watt
3200 K - Brightest	10,040	27,008	572	47.2
3200 K - Hybrid	7,851	21,120	*	*
3200 K - Spectral	5,663	15,233	*	*
4500 K - Brightest	11,923	32,072	705	45.5
4500 K - Hybrid	10,108	27,191	*	*
4500 K - Spectral	8,298	22,322	*	*
5600 K - Brightest	12,865	34,608	791	43.8
5600 K - Hybrid	11,061	29,756	*	*
5600 K - Spectral	9,263	24,918	*	*

Illuminance (footcandles)

Mode	1 m	2 m	3 m
3200 K - Brightest	929	242	108
3200 K - Hybrid	726	189	84
3200 K - Spectral	524	137	61
4500 K - Brightest	1,103	288	128
4500 K - Hybrid	935	244	108
4500 K - Spectral	768	200	89
5600 K - Brightest	1,190	310	138
5600 K - Hybrid	1,023	267	119
5600 K - Spectral	857	224	99

To determine center beam illumination in footcandles at large distances, divide candela by the throw distance squared. For field diameter at large distances, multiply distance by 9.021. For beam diameter at large distances, multiply by 2.654. Metric conversions: For feet, multiply meters by 3.2808. For lux, multiply footcandles by 10.76. *Note: Wattage for modes other than Brightest can vary from fixture to fixture based on LEDs but will not exceed Brightest..

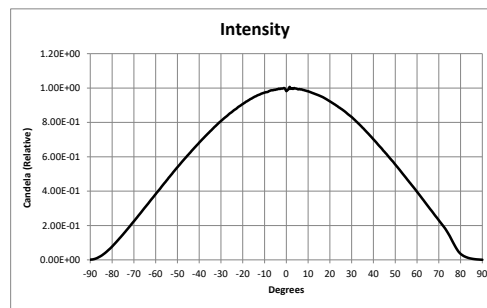

fos/4 Panel Medium Lustr X8 (PL16) - Light Diffuser

Mode	Candela	Total Lumens	Power Consumption	Lumens Per Watt
3200 K - Brightest	10,344	26,942	572	47.1
3200 K - Hybrid	8,089	21,069	*	*
3200 K - Spectral	5,834	15,195	*	*
4500 K - Brightest	12,284	31,994	705	45.4
4500 K - Hybrid	10,414	27,125	*	*
4500 K - Spectral	8,549	22,268	*	*
5600 K - Brightest	13,255	34,523	791	43.6
5600 K - Hybrid	11,396	29,683	*	*
5600 K - Spectral	9,543	24,857	*	*

Illuminance (footcandles)

Mode	1 m	2 m	3 m
3200 K - Brightest	963	255	114
3200 K - Hybrid	753	200	89
3200 K - Spectral	543	144	64
4500 K - Brightest	1,144	303	135
4500 K - Hybrid	970	257	114
4500 K - Spectral	796	211	94
5600 K - Brightest	1,234	327	145
5600 K - Hybrid	1,061	281	125
5600 K - Spectral	889	236	105

To determine center beam illumination in footcandles at large distances, divide candela by the throw distance squared. For field diameter at large distances, multiply distance by 8.663. For beam diameter at large distances, multiply by 2.560. Metric conversions: For feet, multiply meters by 3.2808. For lux, multiply footcandles by 10.76. *Note: Wattage for modes other than Brightest can vary from fixture to fixture based on LEDs but will not exceed Brightest.

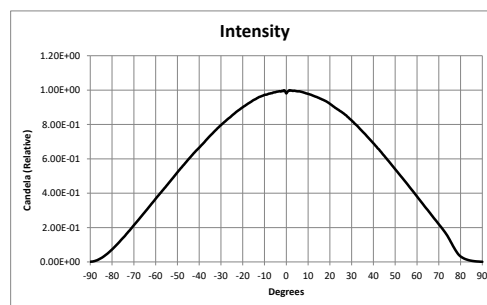

PHOTOMETRY INFORMATION

fos/4 Panel Medium Lustr X8 (PL16) - Heavy Diffuser

Illuminance (footcandles)

Mode	Candela	Total Lumens	Power Consumption	Lumens Per Watt
3200 K - Brightest	8,936	24,112	572	42.2
3200 K - Hybrid	6,988	18,856	*	*
3200 K - Spectral	5,040	13,599	*	*
4500 K - Brightest	10,612	28,633	705	40.6
4500 K - Hybrid	8,997	24,275	*	*
4500 K - Spectral	7,386	19,929	*	*
5600 K - Brightest	11,451	30,897	791	39.1
5600 K - Hybrid	9,845	26,565	*	*
5600 K - Spectral	8,244	22,246	*	*

Mode	1 m	2 m	3 m
3200 K - Brightest	802	213	95
3200 K - Hybrid	627	166	74
3200 K - Spectral	452	120	53
4500 K - Brightest	953	253	112
4500 K - Hybrid	808	214	95
4500 K - Spectral	663	176	78
5600 K - Brightest	1,028	273	121
5600 K - Hybrid	884	235	104
5600 K - Spectral	740	196	87

To determine center beam illumination in footcandles at large distances, divide candela by the throw distance squared. For field diameter at large distances, multiply distance by 9.021. For beam diameter at large distances, multiply by 2.753. Metric conversions: For feet, multiply meters by 3.2808. For lux, multiply footcandles by 10.76. *Note: Wattage for modes other than Brightest can vary from fixture to fixture based on LEDs but will not exceed Brightest.

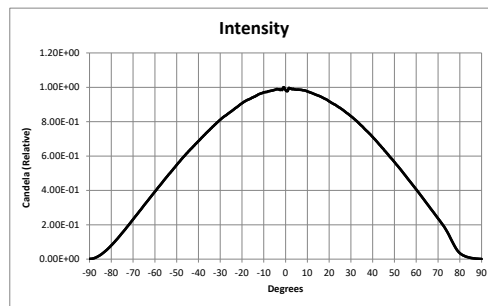

fos/4 Panel Medium Lustr X8 (PL16) - Intensifier Diffuser

Illuminance (footcandles)

Mode	Candela	Total Lumens	Power Consumption	Lumens Per Watt
3200 K - Brightest	17,154	15,682	572	27.4
3200 K - Hybrid	13,414	12,263	*	*
3200 K - Spectral	9,675	8,845	*	*
4500 K - Brightest	20,371	18,623	705	26.4
4500 K - Hybrid	17,270	15,788	*	*
4500 K - Spectral	14,178	12,961	*	*
5600 K - Brightest	21,981	20,095	791	25.4
5600 K - Hybrid	18,899	17,277	*	*
5600 K - Spectral	15,826	14,468	*	*

Mode	1 m	2 m	3 m
3200 K - Brightest	1570	434	193
3200 K - Hybrid	1,228	340	151
3200 K - Spectral	886	245	109
4500 K - Brightest	1,865	516	229
4500 K - Hybrid	1,581	437	194
4500 K - Spectral	1,298	359	160
5600 K - Brightest	2,012	557	247
5600 K - Hybrid	1,730	478	213
5600 K - Spectral	1,449	401	178

To determine center beam illumination in footcandles at large distances, divide candela by the throw distance squared. For field diameter at large distances, multiply distance by 9.021. For beam diameter at large distances, multiply by 2.753. Metric conversions: For feet, multiply meters by 3.2808. For lux, multiply footcandles by 10.76. *Note: Wattage for modes other than Brightest can vary from fixture to fixture based on LEDs but will not exceed Brightest.

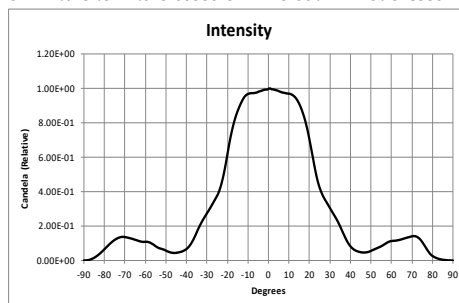

PHOTOMETRY INFORMATION

fos/4 Panel Large Lustr X8 (PL24) - Standard Diffuser

Mode	Candela	Total Lumens	Power Consumption	Lumens Per Watt
3200 K - Brightest	15,060	40,512	848	47.8
3200 K - Hybrid	11,777	31,680	*	*
3200 K - Spectral	8,494	22,849	*	*
4500 K - Brightest	17,884	48,109	1,047	45.9
4500 K - Hybrid	15,162	40,786	*	*
4500 K - Spectral	12,447	33,484	*	*
5600 K - Brightest	19,298	51,912	1,174	44.2
5600 K - Hybrid	16,592	44,634	*	*
5600 K - Spectral	13,894	37,376	*	*

Illuminance (footcandles)

Mode	1 m	2 m	3 m
3200 K - Brightest	1,394	363	162
3200 K - Hybrid	1,090	284	126
3200 K - Spectral	786	205	91
4500 K - Brightest	1,655	432	192
4500 K - Hybrid	1,403	366	163
4500 K - Spectral	1,152	300	134
5600 K - Brightest	1,786	466	207
5600 K - Hybrid	1,535	400	178
5600 K - Spectral	1,286	335	149

To determine center beam illumination in footcandles at large distances, divide candela by the throw distance squared.
 For field diameter at large distances, multiply distance by 9.021. For beam diameter at large distances, multiply by 2.654.
 Metric conversions: For feet, multiply meters by 3.2808. For lux, multiply footcandles by 10.76.
 *Note: Wattage for modes other than Brightest can vary from fixture to fixture based on LEDs but will not exceed Brightest.

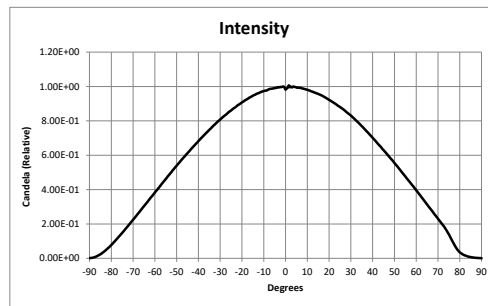

fos/4 Panel Large Lustr X8 (PL24) - Light Diffuser

Mode	Candela	Total Lumens	Power Consumption	Lumens Per Watt
3200 K - Brightest	15,516	40,413	848	47.7
3200 K - Hybrid	12,134	31,603	*	*
3200 K - Spectral	8,751	22,793	*	*
4500 K - Brightest	18,425	47,991	1,047	45.8
4500 K - Hybrid	15,621	40,687	*	*
4500 K - Spectral	12,824	33,402	*	*
5600 K - Brightest	19,882	51,785	1,174	44.1
5600 K - Hybrid	17,095	44,525	*	*
5600 K - Spectral	14,315	37,285	*	*

Illuminance (footcandles)

Mode	1 m	2 m	3 m
3200 K - Brightest	1,445	383	170
3200 K - Hybrid	1,130	300	133
3200 K - Spectral	815	216	96
4500 K - Brightest	1,715	455	202
4500 K - Hybrid	1,454	386	171
4500 K - Spectral	1,194	317	141
5600 K - Brightest	1,851	491	218
5600 K - Hybrid	1,592	422	188
5600 K - Spectral	1,333	353	157

To determine center beam illumination in footcandles at large distances, divide candela by the throw distance squared.
 For field diameter at large distances, multiply distance by 8.663. For beam diameter at large distances, multiply by 2.560.
 Metric conversions: For feet, multiply meters by 3.2808. For lux, multiply footcandles by 10.76.
 *Note: Wattage for modes other than Brightest can vary from fixture to fixture based on LEDs but will not exceed Brightest.

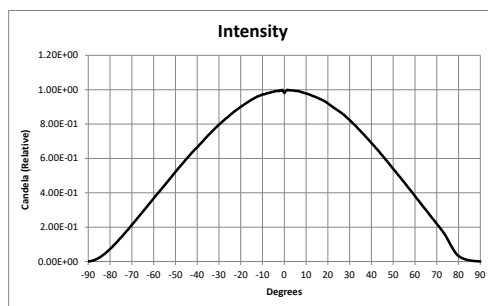

PHOTOMETRY INFORMATION

fos/4 Panel Large Lustr X8 (PL24) - Heavy Diffuser

Mode	Candela	Total Lumens	Power Consumption	Lumens Per Watt
3200 K - Brightest	13,404	36,168	848	42.7
3200 K - Hybrid	10,482	28,283	*	*
3200 K - Spectral	7,560	20,399	*	*
4500 K - Brightest	15,917	42,950	1,047	41.0
4500 K - Hybrid	13,495	36,413	*	*
4500 K - Spectral	11,079	29,893	*	*
5600 K - Brightest	17,176	46,345	1,174	39.5
5600 K - Hybrid	14,768	39,848	*	*
5600 K - Spectral	12,367	33,369	*	*

Illuminance (footcandles)

Mode	1 m	2 m	3 m
3200 K - Brightest	1,203	319	142
3200 K - Hybrid	941	250	111
3200 K - Spectral	679	180	80
4500 K - Brightest	1,429	379	169
4500 K - Hybrid	1,211	322	143
4500 K - Spectral	995	264	117
5600 K - Brightest	1,542	409	182
5600 K - Hybrid	1,326	352	156
5600 K - Spectral	1,110	295	131

To determine center beam illumination in footcandles at large distances, divide candela by the throw distance squared.
 For field diameter at large distances, multiply distance by 9.021. For beam diameter at large distances, multiply by 2.753.
 Metric conversions: For feet, multiply meters by 3.2808. For lux, multiply footcandles by 10.76.
 *Note: Wattage for modes other than Brightest can vary from fixture to fixture based on LEDs but will not exceed Brightest.

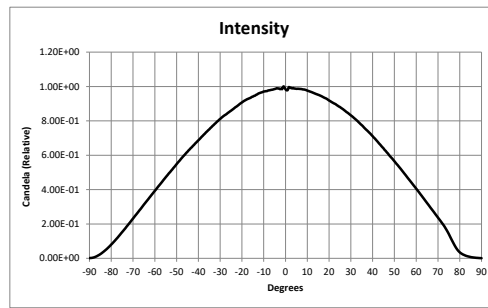

fos/4 Panel Large Lustr X8 (PL24) - Intensifier Diffuser

Mode	Candela	Total Lumens	Power Consumption	Lumens Per Watt
3200 K - Brightest	25,731	23,523	848	27.7
3200 K - Hybrid	20,122	18,395	*	*
3200 K - Spectral	14,512	13,267	*	*
4500 K - Brightest	30,556	27,934	1047	26.7
4500 K - Hybrid	25,905	23,682	*	*
4500 K - Spectral	21,267	19,442	*	*
5600 K - Brightest	32,971	30,142	1174	25.7
5600 K - Hybrid	28,349	25,916	*	*
5600 K - Spectral	23,739	21,702	*	*

Illuminance (footcandles)

Mode	1 m	2 m	3 m
3200 K - Brightest	2334	661	294
3200 K - Hybrid	1,825	517	230
3200 K - Spectral	1,316	373	166
4500 K - Brightest	2,771	784	349
4500 K - Hybrid	2,350	665	296
4500 K - Spectral	1,929	546	243
5600 K - Brightest	2,990	846	376
5600 K - Hybrid	2,571	728	323
5600 K - Spectral	2,153	609	271

To determine center beam illumination in footcandles at large distances, divide candela by the throw distance squared.
 For field diameter at large distances, multiply distance by 9.021. For beam diameter at large distances, multiply by 2.654.
 Metric conversions: For feet, multiply meters by 3.2808. For lux, multiply footcandles by 10.76.
 *Note: Wattage for modes other than Brightest can vary from fixture to fixture based on LEDs but will not exceed Brightest.

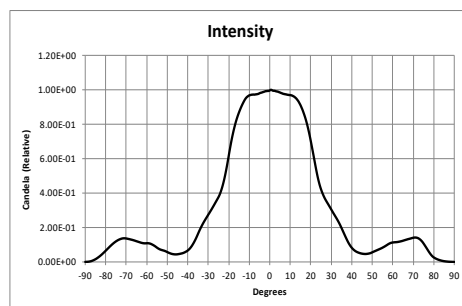

PHOTOMETRY INFORMATION

fos/4 Panel Small Daylight HDR (PD8) - Standard Diffuser

Illuminance (footcandles)

Mode	Candela	Total Lumens	Power Consumption	Lumens Per Watt
3200 K - Brightest	2,567	6,959	282	24.7
3200 K - Hybrid	2,217	6,012	*	*
3200 K - Spectral	1,869	5,066	*	*
4500 K - Brightest	5,234	14,191	350	40.5
4500 K - Hybrid	4,096	11,105	*	*
4500 K - Spectral	2,957	8,018	*	*
5600 K - Brightest	7,572	20,529	391	52.5
5600 K - Hybrid	5,820	15,779	*	*
5600 K - Spectral	4,066	11,024	*	*

Mode	1 m	2 m	3 m
3200 K - Brightest	221	56	25
3200 K - Hybrid	191	49	22
3200 K - Spectral	161	41	18
4500 K - Brightest	452	115	51
4500 K - Hybrid	354	90	40
4500 K - Spectral	255	65	29
5600 K - Brightest	654	167	74
5600 K - Hybrid	502	128	57
5600 K - Spectral	351	90	40

To determine center beam illumination in footcandles at large distances, divide candela by the throw distance squared.
 For field diameter at large distances, multiply distance by 9.021. For beam diameter at large distances, multiply by 2.654.
 Metric conversions: For feet, multiply meters by 3.2808. For lux, multiply footcandles by 10.76.
 *Note: Wattage for modes other than Brightest can vary from fixture to fixture based on LEDs but will not exceed Brightest.

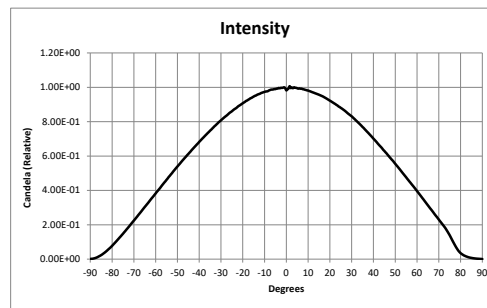

fos/4 Panel Small Daylight HDR (PD8) - Light Diffuser

Illuminance (footcandles)

Mode	Candela	Total Lumens	Power Consumption	Lumens Per Watt
3200 K - Brightest	2,644	6,943	282	24.6
3200 K - Hybrid	2,285	5,998	*	*
3200 K - Spectral	1,925	5,054	*	*
4500 K - Brightest	5,393	14,157	350	40.4
4500 K - Hybrid	4,220	11,078	*	*
4500 K - Spectral	3,047	7,999	*	*
5600 K - Brightest	7,801	20,480	391	52.4
5600 K - Hybrid	5,996	15,741	*	*
5600 K - Spectral	4,189	10,998	*	*

Mode	1 m	2 m	3 m
3200 K - Brightest	235	58	26
3200 K - Hybrid	203	50	22
3200 K - Spectral	171	42	19
4500 K - Brightest	479	117	52
4500 K - Hybrid	375	92	41
4500 K - Spectral	271	66	29
5600 K - Brightest	694	170	76
5600 K - Hybrid	533	131	58
5600 K - Spectral	372	91	41

To determine center beam illumination in footcandles at large distances, divide candela by the throw distance squared.
 For field diameter at large distances, multiply distance by 8.663. For beam diameter at large distances, multiply by 2.560.
 Metric conversions: For feet, multiply meters by 3.2808. For lux, multiply footcandles by 10.76.
 *Note: Wattage for modes other than Brightest can vary from fixture to fixture based on LEDs but will not exceed Brightest.

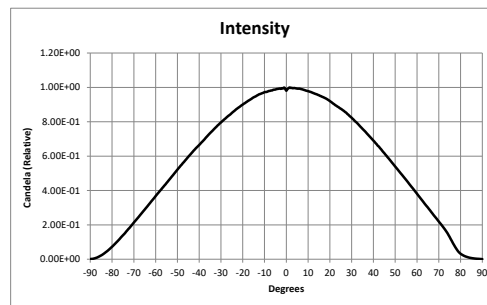

PHOTOMETRY INFORMATION

fos/4 Panel Small Daylight HDR (PD8) - Heavy Diffuser

Mode	Candela	Total Lumens	Power Consumption	Lumens Per Watt
3200 K - Brightest	2,285	6,214	282	22.0
3200 K - Hybrid	1,974	5,368	*	*
3200 K - Spectral	1,663	4,523	*	*
4500 K - Brightest	4,659	12,671	350	36.2
4500 K - Hybrid	3,645	9,915	*	*
4500 K - Spectral	2,632	7,159	*	*
5600 K - Brightest	6,739	18,330	391	46.9
5600 K - Hybrid	5,180	14,088	*	*
5600 K - Spectral	3,619	9,843	*	*

Illuminance (footcandles)

Mode	1 m	2 m	3 m
3200 K - Brightest	205	53	24
3200 K - Hybrid	177	46	20
3200 K - Spectral	149	39	17
4500 K - Brightest	419	109	48
4500 K - Hybrid	327	85	38
4500 K - Spectral	236	61	27
5600 K - Brightest	605	157	70
5600 K - Hybrid	465	121	54
5600 K - Spectral	325	84	38

To determine center beam illumination in footcandles at large distances, divide candela by the throw distance squared. For field diameter at large distances, multiply distance by 9.021. For beam diameter at large distances, multiply by 2.753. Metric conversions: For feet, multiply meters by 3.2808. For lux, multiply footcandles by 10.76. *Note: Wattage for modes other than Brightest can vary from fixture to fixture based on LEDs but will not exceed Brightest.

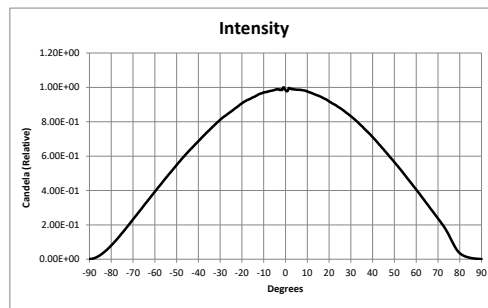

fos/4 Panel Small Daylight HDR (PD8) - Intensifier Diffuser

Mode	Candela	Total Lumens	Power Consumption	Lumens Per Watt
3200 K - Brightest	4,385	4,041	282	14.3
3200 K - Hybrid	3,789	3,491	*	*
3200 K - Spectral	3,193	2,942	*	*
4500 K - Brightest	8,943	8,240	350	23.5
4500 K - Hybrid	6,998	6,448	*	*
4500 K - Spectral	5,053	4,656	*	*
5600 K - Brightest	12,937	11,920	391	30.5
5600 K - Hybrid	9,943	9,162	*	*
5600 K - Spectral	6,947	6,401	*	*

Illuminance (footcandles)

Mode	1 m	2 m	3 m
3200 K - Brightest	376.2	105	47
3200 K - Hybrid	325	91	40
3200 K - Spectral	274	77	34
4500 K - Brightest	768	215	95
4500 K - Hybrid	601	168	75
4500 K - Spectral	434	121	54
5600 K - Brightest	1,111	311	138
5600 K - Hybrid	854	239	106
5600 K - Spectral	597	167	74

To determine center beam illumination in footcandles at large distances, divide candela by the throw distance squared. For field diameter at large distances, multiply distance by 9.021. For beam diameter at large distances, multiply by 2.753. Metric conversions: For feet, multiply meters by 3.2808. For lux, multiply footcandles by 10.76. *Note: Wattage for modes other than Brightest can vary from fixture to fixture based on LEDs but will not exceed Brightest.

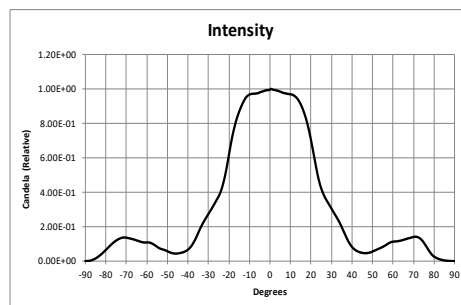

PHOTOMETRY INFORMATION

fos/4 Panel Medium Daylight HDR (PD16) - Standard Diffuser

Mode	Candela	Total Lumens	Power Consumption	Lumens Per Watt
3200 K - Brightest	5,133	13,918	298	46.7
3200 K - Hybrid	4,435	12,024	*	*
3200 K - Spectral	3,737	10,133	*	*
4500 K - Brightest	10,468	28,383	532	53.4
4500 K - Hybrid	8,191	22,209	*	*
4500 K - Spectral	5,915	16,036	*	*
5600 K - Brightest	15,143	41,058	784	52.4
5600 K - Hybrid	11,639	31,558	*	*
5600 K - Spectral	8,132	22,048	*	*

Illuminance (footcandles)

Mode	1 m	2 m	3 m
3200 K - Brightest	443	113	50
3200 K - Hybrid	383	98	43
3200 K - Spectral	322	82	37
4500 K - Brightest	904	230	102
4500 K - Hybrid	707	180	80
4500 K - Spectral	511	130	58
5600 K - Brightest	1,308	333	148
5600 K - Hybrid	1,005	256	114
5600 K - Spectral	702	179	80

To determine center beam illumination in footcandles at large distances, divide candela by the throw distance squared. For field diameter at large distances, multiply distance by 9.021. For beam diameter at large distances, multiply by 2.654. Metric conversions: For feet, multiply meters by 3.2808. For lux, multiply footcandles by 10.76. *Note: Wattage for modes other than Brightest can vary from fixture to fixture based on LEDs but will not exceed Brightest.

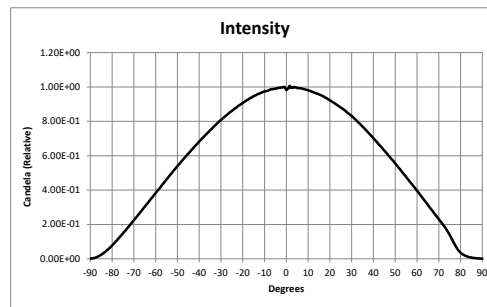

fos/4 Panel Medium Daylight HDR (PD16) - Light Diffuser

Mode	Candela	Total Lumens	Power Consumption	Lumens Per Watt
3200 K - Brightest	5,289	13,885	298	46.6
3200 K - Hybrid	4,569	11,995	*	*
3200 K - Spectral	3,850	10,108	*	*
4500 K - Brightest	10,785	28,315	532	53.2
4500 K - Hybrid	8,440	22,156	*	*
4500 K - Spectral	6,094	15,998	*	*
5600 K - Brightest	15,602	40,960	784	52.2
5600 K - Hybrid	11,992	31,482	*	*
5600 K - Spectral	8,378	21,996	*	*

Illuminance (footcandles)

Mode	1 m	2 m	3 m
3200 K - Brightest	470	115	51
3200 K - Hybrid	406	99	44
3200 K - Spectral	342	84	37
4500 K - Brightest	959	235	104
4500 K - Hybrid	750	184	82
4500 K - Spectral	542	133	59
5600 K - Brightest	1,387	340	151
5600 K - Hybrid	1,066	261	116
5600 K - Spectral	745	183	81

To determine center beam illumination in footcandles at large distances, divide candela by the throw distance squared. For field diameter at large distances, multiply distance by 8.663. For beam diameter at large distances, multiply by 2.560. Metric conversions: For feet, multiply meters by 3.2808. For lux, multiply footcandles by 10.76. *Note: Wattage for modes other than Brightest can vary from fixture to fixture based on LEDs but will not exceed Brightest.

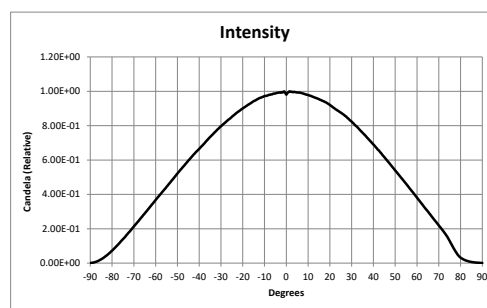

PHOTOMETRY INFORMATION

fos/4 Panel Medium Daylight HDR (PD16) - Heavy Diffuser

Illuminance (footcandles)

Mode	Candela	Total Lumens	Power Consumption	Lumens Per Watt
3200 K - Brightest	4,569	12,427	298	41.7
3200 K - Hybrid	3,947	10,736	*	*
3200 K - Spectral	3,326	9,047	*	*
4500 K - Brightest	9,317	25,342	532	47.6
4500 K - Hybrid	7,291	19,830	*	*
4500 K - Spectral	5,264	14,318	*	*
5600 K - Brightest	13,478	36,659	784	46.8
5600 K - Hybrid	10,360	28,177	*	*
5600 K - Spectral	7,238	19,686	*	*

Mode	1 m	2 m	3 m
3200 K - Brightest	410	107	47
3200 K - Hybrid	354	92	41
3200 K - Spectral	298	78	34
4500 K - Brightest	836	217	97
4500 K - Hybrid	654	170	76
4500 K - Spectral	472	123	55
5600 K - Brightest	1,209	314	107
5600 K - Hybrid	929	242	107
5600 K - Spectral	649	169	75

To determine center beam illumination in footcandles at large distances, divide candela by the throw distance squared.
 For field diameter at large distances, multiply distance by 9.021. For beam diameter at large distances, multiply by 2.753.
 Metric conversions: For feet, multiply meters by 3.2808. For lux, multiply footcandles by 10.76.
 *Note: Wattage for modes other than Brightest can vary from fixture to fixture based on LEDs but will not exceed Brightest.

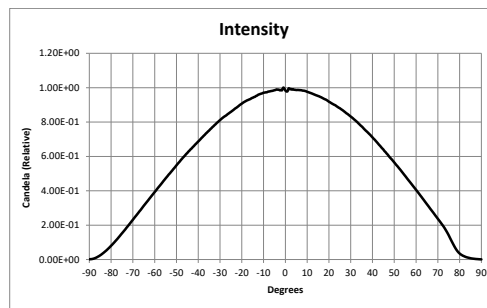

fos/4 Panel Medium Daylight HDR (PD16) - Intensifier Diffuser

Illuminance (footcandles)

Mode	Candela	Total Lumens	Power Consumption	Lumens Per Watt
3200 K - Brightest	8,771	8,082	298	27.1
3200 K - Hybrid	7,577	6,982	*	*
3200 K - Spectral	6,385	5,884	*	*
4500 K - Brightest	17,886	16,481	532	31.0
4500 K - Hybrid	13,996	12,896	*	*
4500 K - Spectral	10,106	9,312	*	*
5600 K - Brightest	25,874	23,841	784	30.4
5600 K - Hybrid	19,887	18,324	*	*
5600 K - Spectral	13,894	12,803	*	*

Mode	1 m	2 m	3 m
3200 K - Brightest	780	226	100
3200 K - Hybrid	674	195	87
3200 K - Spectral	568	164	73
4500 K - Brightest	1,592	461	205
4500 K - Hybrid	1,246	361	160
4500 K - Spectral	899	260	116
5600 K - Brightest	2,304	667	296
5600 K - Hybrid	1,771	512	228
5600 K - Spectral	1,237	358	159

To determine center beam illumination in footcandles at large distances, divide candela by the throw distance squared.
 For field diameter at large distances, multiply distance by 9.021. For beam diameter at large distances, multiply by 2.654.
 Metric conversions: For feet, multiply meters by 3.2808. For lux, multiply footcandles by 10.76.
 *Note: Wattage for modes other than Brightest can vary from fixture to fixture based on LEDs but will not exceed Brightest.

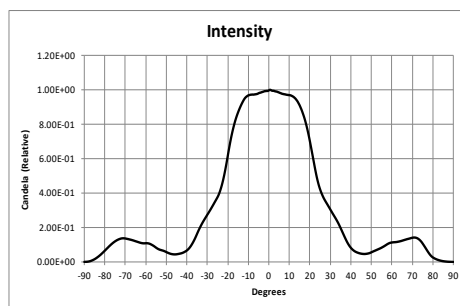

PHOTOMETRY INFORMATION

fos/4 Panel Large Daylight HDR (PD24) - Standard Diffuser

Illuminance (footcandles)

Mode	Candela	Total Lumens	Power Consumption	Lumens Per Watt
3200 K - Brightest	7,700	20,878	448	46.6
3200 K - Hybrid	6,652	18,036	*	*
3200 K - Spectral	5,606	15,199	*	*
4500 K - Brightest	15,702	42,574	814	52.3
4500 K - Hybrid	12,287	33,314	*	*
4500 K - Spectral	8,872	24,054	*	*
5600 K - Brightest	22,715	61,587	1,184	52.0
5600 K - Hybrid	17,459	47,337	*	*
5600 K - Spectral	12,198	33,072	*	*

Mode	1 m	2 m	3 m
3200 K - Brightest	664	169	75
3200 K - Hybrid	574	146	65
3200 K - Spectral	484	123	55
4500 K - Brightest	1,355	346	154
4500 K - Hybrid	1,061	270	120
4500 K - Spectral	766	195	87
5600 K - Brightest	1,961	500	222
5600 K - Hybrid	1,507	384	171
5600 K - Spectral	1,053	269	119

To determine center beam illumination in footcandles at large distances, divide candela by the throw distance squared.
 For field diameter at large distances, multiply distance by 9.021. For beam diameter at large distances, multiply by 2.654.
 Metric conversions: For feet, multiply meters by 3.2808. For lux, multiply footcandles by 10.76.
 *Note: Wattage for modes other than Brightest can vary from fixture to fixture based on LEDs but will not exceed Brightest.

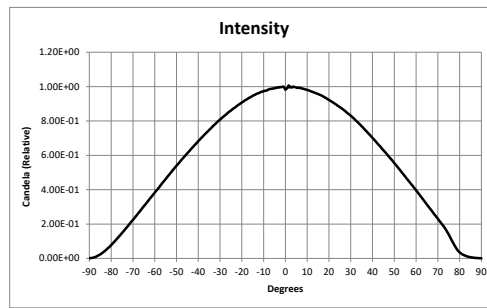

fos/4 Panel Large Daylight HDR (PD24) - Light Diffuser

Illuminance (footcandles)

Mode	Candela	Total Lumens	Power Consumption	Lumens Per Watt
3200 K - Brightest	7,933	20,828	448	46.5
3200 K - Hybrid	6,854	17,993	*	*
3200 K - Spectral	5,776	15,162	*	*
4500 K - Brightest	16,178	42,472	814	52.2
4500 K - Hybrid	12,659	33,234	*	*
4500 K - Spectral	9,141	23,997	*	*
5600 K - Brightest	23,403	61,440	1,184	51.9
5600 K - Hybrid	17,988	47,223	*	*
5600 K - Spectral	12,567	32,993	*	*

Mode	1 m	2 m	3 m
3200 K - Brightest	705	173	77
3200 K - Hybrid	609	149	66
3200 K - Spectral	513	126	56
4500 K - Brightest	1,438	352	157
4500 K - Hybrid	1,125	276	123
4500 K - Spectral	812	199	88
5600 K - Brightest	2,081	510	227
5600 K - Hybrid	1,599	392	174
5600 K - Spectral	1,117	274	122

To determine center beam illumination in footcandles at large distances, divide candela by the throw distance squared.
 For field diameter at large distances, multiply distance by 8.663. For beam diameter at large distances, multiply by 2.560.
 Metric conversions: For feet, multiply meters by 3.2808. For lux, multiply footcandles by 10.76.
 *Note: Wattage for modes other than Brightest can vary from fixture to fixture based on LEDs but will not exceed Brightest.

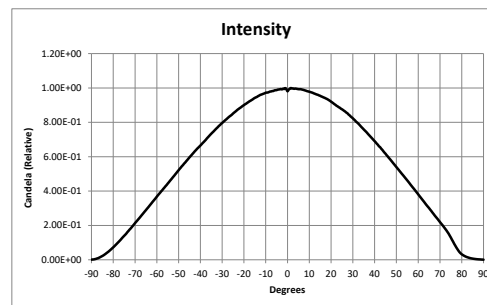

PHOTOMETRY INFORMATION

fos/4 Panel Large Daylight HDR (PD24) - Heavy Diffuser

Mode	Candela	Total Lumens	Power Consumption	Lumens Per Watt
3200 K - Brightest	6,854	18,641	448	41.6
3200 K - Hybrid	5,921	16,104	*	*
3200 K - Spectral	4,989	13,570	*	*
4500 K - Brightest	13,976	38,013	814	46.7
4500 K - Hybrid	10,936	29,745	*	*
4500 K - Spectral	7,896	21,477	*	*
5600 K - Brightest	20,217	54,989	1,184	46.4
5600 K - Hybrid	15,539	42,265	*	*
5600 K - Spectral	10,857	29,529	*	*

Illuminance (footcandles)

Mode	1 m	2 m	3 m
3200 K - Brightest	614	160	71
3200 K - Hybrid	531	138	61
3200 K - Spectral	447	116	52
4500 K - Brightest	1,253	326	145
4500 K - Hybrid	981	255	113
4500 K - Spectral	708	184	82
5600 K - Brightest	1,814	472	210
5600 K - Hybrid	1,394	363	161
5600 K - Spectral	974	253	113

To determine center beam illumination in footcandles at large distances, divide candela by the throw distance squared.
 For field diameter at large distances, multiply distance by 9.021. For beam diameter at large distances, multiply by 2.753.
 Metric conversions: For feet, multiply meters by 3.2808. For lux, multiply footcandles by 10.76.
 *Note: Wattage for modes other than Brightest can vary from fixture to fixture based on LEDs but will not exceed Brightest.

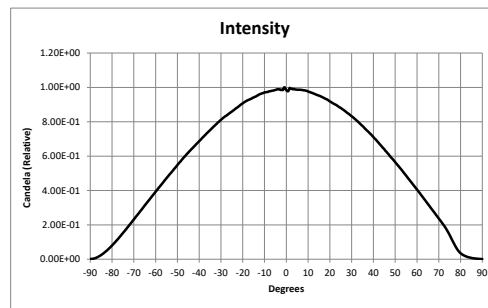

fos/4 Panel Large Daylight HDR (PD24) - Intensifier Diffuser

Mode	Candela	Total Lumens	Power Consumption	Lumens Per Watt
3200 K - Brightest	13,156	12,123	448	27.1
3200 K - Hybrid	11,366	10,473	*	*
3200 K - Spectral	9,578	8,825	*	*
4500 K - Brightest	26,829	24,721	814	30.4
4500 K - Hybrid	20,994	19,344	*	*
4500 K - Spectral	15,158	13,967	*	*
5600 K - Brightest	38,810	35,761	1184	30.2
5600 K - Hybrid	29,830	27,487	*	*
5600 K - Spectral	20,841	19,204	*	*

Illuminance (footcandles)

Mode	1 m	2 m	3 m
3200 K - Brightest	1134	341	152
3200 K - Hybrid	980	295	131
3200 K - Spectral	826	248	110
4500 K - Brightest	2,315	696	309
4500 K - Hybrid	1,811	544	242
4500 K - Spectral	1,308	393	175
5600 K - Brightest	3,349	1,007	448
5600 K - Hybrid	2,574	774	344
5600 K - Spectral	1,799	541	240

To determine center beam illumination in footcandles at large distances, divide candela by the throw distance squared.
 For field diameter at large distances, multiply distance by 9.021. For beam diameter at large distances, multiply by 2.753.
 Metric conversions: For feet, multiply meters by 3.2808. For lux, multiply footcandles by 10.76.
 *Note: Wattage for modes other than Brightest can vary from fixture to fixture based on LEDs but will not exceed Brightest.

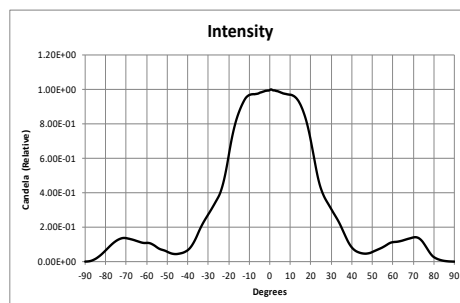

ADDITIONAL ORDERING INFORMATION

Power Input Cables

Use information below to order 5 ft power input leads with factory-fitted connectors. CE fixtures ship with 2 m powerCON® TRUE1 TOP to bare end (2500B7035). One cable of your choice is included with each fixture.

Model	Description	Part Number (not CE)	
T1PA-A	5 ft TRUE1 TOP to parallel blade U-ground (Edison) connector	2500B7029-A	
T1PA-B	5 ft TRUE1 TOP to 20 A two-pin and ground (stage-pin) connector	2500B7029-B	
T1PA-C	5 ft TRUE1 TOP to grounded 20 A twistlock connector	2500B7029-C	
T1PA-X	5 ft TRUE1 TOP to bare-end power input lead	2500B7029-X	

Power Thru Jumpers

Power thru jumpers connect to output (thru) connectors on small and medium panels to provide power to a successive luminaires inline.

Model	Description	Part Number	
T1PJ-5	5 ft TRUE1 TOP to TRUE1 TOP fixture to fixture jumper (ETL only)	2500B7030	
T1PJ-10	10 ft TRUE1 TOP to TRUE1 TOP fixture to fixture jumper (ETL only)	2500B7031	

Diffusion and Intensifiers

Model	Description	Part Number	
fos4P8LD	fos/4 Panel light diffusion, small	7471K1007	
fos4P8SD	fos/4 Panel standard diffusion, small	7471K1001	
fos4P8HD	fos/4 Panel heavy diffusion, small	7471K1010	
fos4P8I	fos/4 Panel intensifier, small	7471K1004	
	fos/4 Panel light and heavy diffusion kit, small	7471K1013	
fos4P16LD	fos/4 Panel light diffusion, medium	7471K1008	
fos4P16SD	fos/4 Panel standard diffusion, medium	7471K1002	
fos4P16HD	fos/4 Panel heavy diffusion, medium	7471K1011	
fos4P16I	fos/4 Panel intensifier, medium	7471K1005	
	fos/4 Panel light & heavy diffusion kit, medium	7471K1014	
fos4P24LD	fos/4 Panel light diffusion, large	7471K1009	
fos4P24SD	fos/4 Panel standard diffusion, large	7471K1003	
fos4P24HD	fos/4 Panel heavy diffusion, large	7471K1012	
fos4P24I	fos/4 Panel intensifier, large	7471K1006	
	fos/4 Panel light and heavy diffusion kit, large	7471K1015	

ADDITIONAL ORDERING INFORMATION

Egg Crates and Honeycombs

Model	Description	Part Number	
fos4P8EC40	fos/4 Panel Chimera® egg crate, 40-degree, small	PSF1137	
fos4P8EC50	fos/4 Panel Chimera egg crate, 50-degree, small	PSF1140	
fos4P8EC60	fos/4 Panel Chimera egg crate, 60-degree, small	PSF1143	
fos4P8HC30	fos/4 Panel honeycomb, 30-degree, small	PSF1146	
fos4P8HC60	fos/4 Panel honeycomb, 60-degree, small	PSF1149	
fos4P16EC40	fos/4 Panel Chimera egg crate, 40-degree, medium	PSF1138	
fos4P16EC50	fos/4 Panel Chimera egg crate, 50-degree, medium	PSF1141	
fos4P16EC60	fos/4 Panel Chimera egg crate, 60-degree, medium	PSF1144	
fos4P16HC30	fos/4 Panel honeycomb, 30-degree, medium	PSF1147	
fos4P16HC60	fos/4 Panel honeycomb, 60-degree, medium	PSF1150	
fos4P24EC40	fos/4 Panel Chimera egg crate, 40-degree, large	PSF1139	
fos4P24EC50	fos/4 Panel Chimera egg crate, 50-degree, large	PSF1142	
fos4P24EC60	fos/4 Panel Chimera egg crate, 60-degree, large	PSF1145	
fos4P24HC30	fos/4 Panel honeycomb, 30-degree, large	PSF1148	
fos4P24HC60	fos/4 Panel honeycomb, 60-degree, large	PSF1151	

Light Banks

Model	Description	Part Number	
fos4P8CPB	Chimera pop bank, small for fos/4 Panel Small	PSF1152	
fos4P16CPB	Chimera pop bank, medium for fos/4 Panel Medium	PSF1153	
fos4P24CPB	Chimera pop bank, large for fos/4 Panel Large	PSF1154	

Barn Doors

Model	Description	Part Number	
fos4P8BD	fos/4 Panel barn door, small	PSF1155	
fos4P16BD	fos/4 Panel barn door, medium	PSF1156	
fos4P24BD	fos/4 Panel barn door, large	PSF1157	

Multiverse

Model	Description	Part Number	
CT-5900	City Theatrical Multiverse Show Baby	4360A1091	
CT-5902	City Theatrical Multiverse Node 900 MHz / 2.4 GHz	4360A1092	
CT-5903	City Theatrical Multiverse Node 2.4 GHz	4360A1093	
CT-5910	City Theatrical Multiverse Transmitter 900 MHz / 2.4 GHz	4360A1094	
CT-5911	City Theatrical Multiverse Transmitter 2.4 GHz	4360A1095	
CT-5912	City Theatrical Multiverse Transmitter 900 MHz	4360A1096	

ADDITIONAL ORDERING INFORMATION

Road Cases

Model	Description	Part Number	
fos4P8RC	fos/4 Panel road case, small	PSR1098	
fos4P16RC	fos/4 Panel road case, medium	PSR1099	
fos4P24RC	fos/4 Panel road case, large	PSR1100	

CYC Adapters

Model	Description	Part Number	
fos4P8CYC	fos/4 Panel CYC Adapter, small	7471A2013	
fos4P16CYC	fos/4 Panel CYC Adapter, medium	7471A2014	
fos4P24CYC	fos/4 Panel CYC Adapter, large	7471A2015	

Double Yoke Kit

Model	Description	Part Number	
fos4P8DY	fos/4 Panel double yoke kit for small panel, black	7471K1047	

Griprails

Model	Description	Part Number	
fos4UMP	fos/4 Panel griprail universal mounting plate	7471K1019	
fos4PGH-S	fos/4 Panel griprail handle, small	7471A2017	
fos4PGH-ML	fos/4 Panel griprail handle, medium/large	7471A2018	
fos4PGCMV	fos/4 Panel Griprail cable management, VELCRO	7471A2016	

PHYSICAL INFORMATION

fos/4 Panel Dimensions

Model	Height		Width		Depth	
	in	mm	in	mm	in	mm
fos/4 Panel - Small	9.35	237	25.43	646	7.38	187
fos/4 Panel - Medium	17.42	442	25.43	646	7.98	203
fos/4 Panel - Large	25.43	646	25.43	646	7.62	194

fos/4 Panel Weights

Model	Weight		Shipping Weight	
	lb	kg	lb	kg
fos/4 Panel - Small	32	14.5	42	19.1
fos/4 Panel - Medium	56	25.4	72	32.7
fos/4 Panel - Large	79	35.8	95	43.1

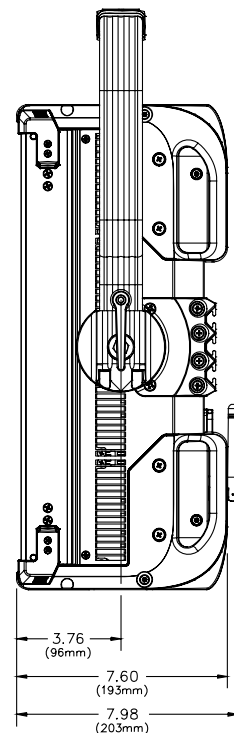
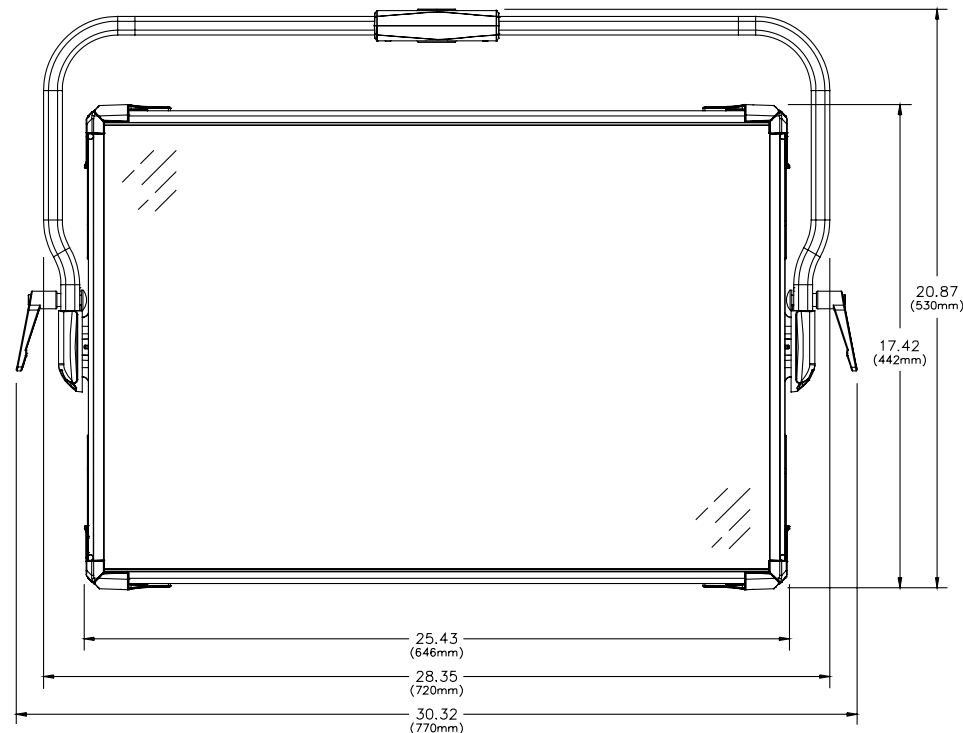
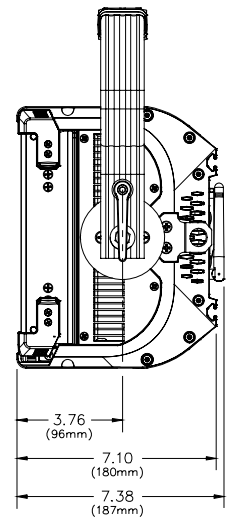
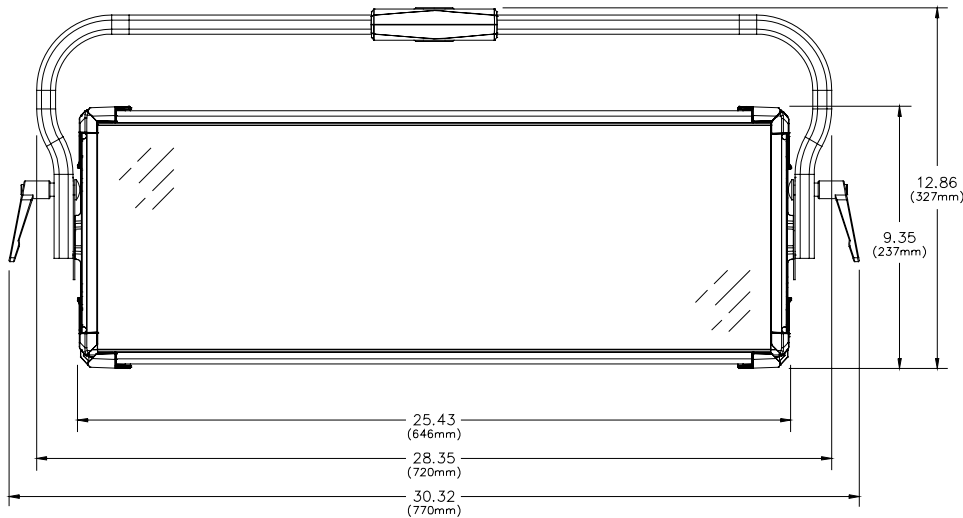

PHYSICAL INFORMATION

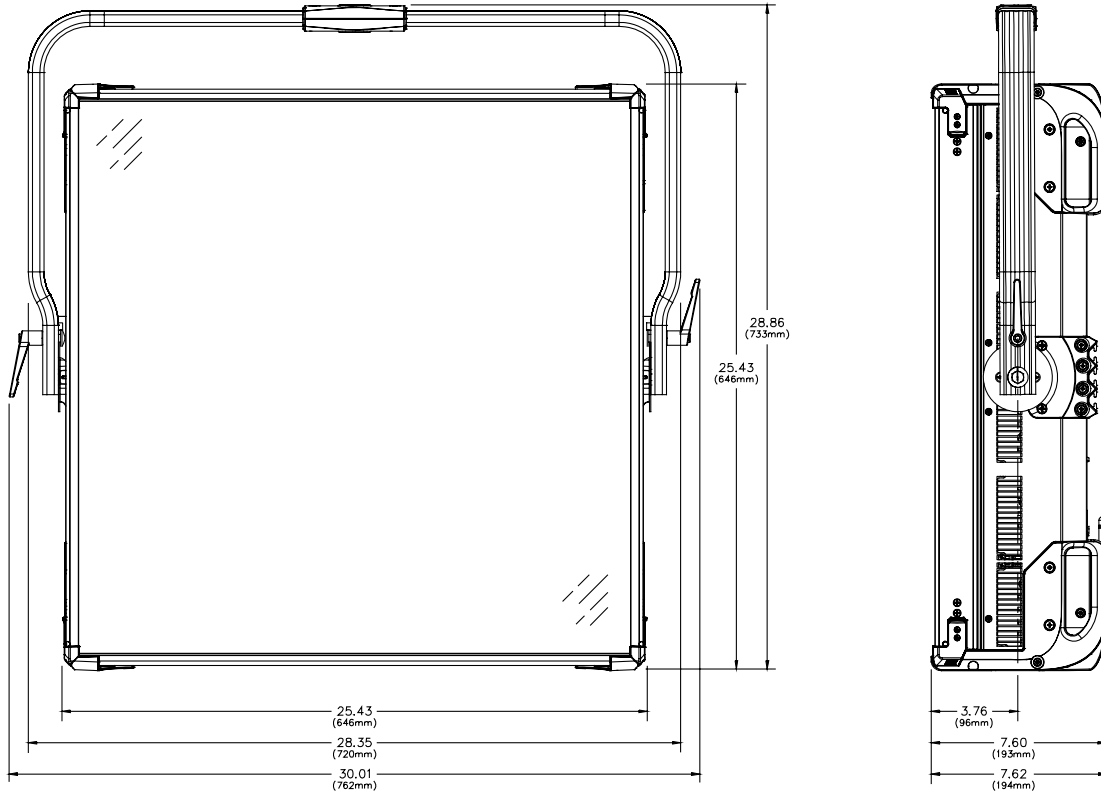

Corporate Headquarters • Middleton, WI USA

Global Offices • London, UK • Rome, IT • Holzkirchen, DE • Paris, FR • Hong Kong
Dubai, UAE • Singapore • New York, NY • Orlando, FL • Los Angeles, CA • Austin, TX

Copyright©2022 ETC. All Rights Reserved. All product information and specifications subject to change. Rev F 2022-04

*Trademark and patent info: etconnect.com/ETC

etconnect.com