

Chroma-Q[®] Space Force[™]

CQSPFV, CQSPFVW
CQSPFVLR

(Model: 650-1000/ CQSPFV Black)
(Model: 650-1100/ CQSPFVW White)
(Model: 650-1500/ CQSPFVLR Black with RF)

User Manual



Chroma-Q[®]
BRILLIANT SOLUTIONS

Software Version 1.70, 2018

Manual: 650-0901

Warranty Statement



Chroma-Q warrants to the original purchaser, with proof of purchase, that its delivered products shall be free from defects in material and workmanship under normal use for a period of 36 months from date of shipment.

Chroma-Q will repair, or at its option, provide an equivalent item or replace, the defective product during the stated warranty period. This warranty applies only to the repair or replacement of the product and only when the product is properly handled, installed and maintained according to Chroma-Q instructions. This warranty excludes defects resulting from improper handling, storage, installation, acts of God, fire, vandalism or civil disturbances. Purchaser must notify Chroma-Q in writing within 14 days of noticing the defect. This warranty excludes field labour or service charges related to the repair or replacement of the product.

The warranty contained herein shall not extend to any finished goods or spare parts from which any serial number has been removed or which have been damaged or rendered defective (a) as a result of normal wear and tear, wilful or accidental damage, negligence, misuse or abuse; (b) due to water or moisture, lightning, windstorm, abnormal voltage, harmonic distortion, dust, dirt, corrosion or other external causes; (c) by operation outside the specifications contained in the user documentation; (d) by the use of spare parts not manufactured or sold by Chroma-Q or by the connection or integration of other equipment or software not approved by Chroma-Q unless the Customer provides acceptable proof to Chroma-Q that the defect or damage was not caused by the above; (e) by modification, repair or service by anyone other than Chroma-Q, who has not applied for and been approved by Chroma-Q to do such modification, repair or service unless the Customer provides acceptable proof to Chroma-Q that the defect or damage was not caused by the above; (f) due to procedures, deviating from procedures specified by Chroma-Q or (g) due to failure to store, install, test, commission, maintain, operate or use finished goods and spare parts in a safe and reasonable manner and in accordance with Chroma-Q's instructions (h) by repair or replacement of engines without factory training.

The warranty contained herein shall not apply to finished goods or spare parts which are sold "as is", as "second-hand", as used", as "demo" or under similar qualifications or to Consumables ("Consumables" is defined as any part(s) of goods or part(s) for use with goods, which part(s) of goods or part(s) for use with goods are consumed during the operation of the goods and which part(s) of goods or part(s) for use with goods require replacement from time to time by a user such as, but not limited to, light bulbs).

The warranty contained herein shall not apply, unless the total purchase price for the defective finished goods or spare parts has been paid by the due date for payment.

The warranty contained herein applies only to the original purchaser and are not assignable or transferable to any subsequent purchaser or end-user.

This warranty is subject to the shipment of the goods, within the warranty period, to the Chroma-Q warranty returns department, by the purchaser, at the purchaser's expense. If no fault is found, Chroma-Q will charge the purchaser for the subsequent return of the goods.

Chroma-Q reserves the right to change the warranty period without prior notice and without incurring obligation and expressly disclaims all warranties not stated in this limited warranty.

Disclaimer

The information contained herein is offered in good faith and is believed to be accurate. However, because conditions and methods of use of our products are beyond our control, this information should not be used in substitution for customer's tests to ensure that Chroma-Q products are safe, effective, and fully satisfactory for the intended end use. Suggestions of use shall not be taken as inducements to infringe any patent. Chroma-Q sole warranty is that the product will meet the sales specifications in effect at the time of shipment. Your exclusive remedy for breach of such warranty is limited to refund of purchase price or replacement of any product shown to be other than as warranted.

Chroma-Q reserves the right to change or make alteration to devices and their functionality without notice due to our ongoing research and development.

The Chroma-Q Space Force range has been designed specifically for the lighting industry. Regular maintenance should be performed to ensure that the products perform well in the entertainment environment.

If you experience any difficulties with any Chroma-Q products please contact your selling dealer. If your selling dealer is unable to help please contact support@chroma-q.com. If the selling dealer is unable to satisfy your servicing needs, please contact the following, for full factory service:

Outside North America:	North America:
Tel: +44 (0)1494 446000	Tel: 416-255-9494
Fax: +44 (0)1494 461024	Fax: 416-255-3514
support@chroma-q.com	support@chroma-q.com

For further information please visit the Chroma-Q website at www.chroma-q.com.

Chroma-Q and Inspire are trademarks, for more information on this visit www.chroma-q.com/trademarks.

The rights and ownership of all trademarks are recognised.

Important Notice:

As per the requirements in the Occupational Safety and Health Administration standards for product approval, please refer to the OSHA web pages <http://www.osha.gov/dts/otpca/nrtl/> for information on the list of Nationally Recognized Testing Laboratories (NRTLs) and the scope of recognition.

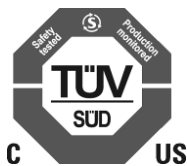

Safety information



WARNING!

Read the safety precautions in this section before installing, powering, operating or servicing this product.



Warning!
Safety Hazard.
Risk of severe injury or death.



Warning!
Fire Hazard.

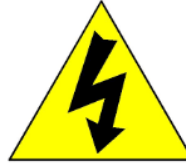

Warning!
Hazardous Voltage.
Risk of severe lethal electric shock.



Warning!
Refer to User manual.

Warning!

- Read the user manual before installing and operating the Chroma-Q Space Force. For future reference, keep and use the manual.
- Safety precautions given in user manual must be followed at all times and the manuals of all the devices you connect it to. Observe all the warnings printed on devices and in manuals. Make sure whoever is involved in working on or using the Space Force has carefully read and understood all the safety precautions and lasted warnings.
- Install, connect, operate and service devices only as described in this manual and in connected devices' manuals and only in accordance with local laws and regulations. All Chroma-Q manuals are supplied with devices and are also available for download from www.chroma-q.com.
- Space Force does not have user-serviceable parts. Refer any operation not described in this manual to support@chroma-q.com.

If you experience difficulties with any Chroma-Q products please contact your local dealer. If your local dealer is unable to help then please contact support@chroma-q.com.

If you are having trouble finding what you are looking for on our website, then contact our Chroma-Q marketing department by sending an email to marketing@chroma-q.com.

PROTECTION FROM ELECTRIC SHOCK

- Use only the cables specified in this manual and on the Chroma-q website at www.chroma-q.com to interconnect devices in the installation. If the specified cables are not long enough for an intended cable run, consult Chroma-Q for assistance in finding or creating a safe alternative solution.
- Provide a means of locking out AC mains power that allows power to the installation to be shut down and made impossible to reapply, even accidentally, during work on the installation.
- Shut down power to the installation during service and when it is not in use.
- Before applying power to the installation, check that all power distribution equipment and cables are in perfect condition and rated for the current requirements of all connected devices.
- Isolate the installation from power immediately if any product, power cable or power plug is in any way damaged, defective or wet, or if it shows signs of overheating.
- Do not immerse a Space Force fixture in water or expose it to high-pressure water jets.

PROTECTION FROM BURNS AND FIRE

- The Space Force is cooled passively by natural air convection. Provide adequate clearance for airflow around the fixtures.
- Do not operate the Space Force, if the ambient temperature (T_a) exceeds 40° C (104° F).
- Do not modify the Space Force, in any way not described in this manual or install other than genuine Chroma-Q parts.
- Use only accessories approved by Chroma-Q.

PROTECTION FROM INJURY

- Ensure that the installation hardware and supporting surface or structure can hold at least 10 times the weight of all the devices they support.
- Block access below the work area and work from a stable platform whenever installing, servicing or moving the Space Force.
- As soon as work is completed, check that all hardware and components are securely fastened to supporting structures.
- Make sure there are no flammable materials close to the product during operation.
- Avoid direct eye exposure to the light source while the product is on.
- Never try to repair the product. Repairs carried out by unskilled people can lead to damage or malfunction. Please contact the nearest authorized dealer or contact support@chroma-q.com.



Keep this User Manual for future consultation. If this product is used by another user, be sure that they also receive this document.

Table of Contents

1. Product overview	6
2. Operation.....	7
2.1 Unpacking the Units	7
2.2 Cabling	7
2.3 Mounting	8
2.4 Control.....	8
2.5 Thermal Performance	19
3. Troubleshooting	20
4. Specification	21
4.1 Technical Specification	21
4.2 Drawings	22
5. Accessories	23
6. Maintenance.....	23

1. Product overview

The new Chroma-Q® Space Force™ is a cutting-edge variable white LED Space Light fixture that is a true replacement for a conventional space light and soft light source commonly used in Film and TV studios around the world. It features extensive RDM functionality through wired or the optional wireless Lumen Radio CRMX connections. Hanging options include a standard bridle, optional yoke and a low-profile hanging bracket.

Smooth, Soft Output

With a high degree of efficiency, the fixture is natively single source, removing the need for skirts or silks to diffuse the light. Designed for lighting stages and studios, the Space Force provides a high-quality, variable CCT soft white light.

As a result of its low profile, lightweight and skirt-free design, the Space Force is quick and easy to set up at any height.

Taking advantage of Chroma-Q's extensive experience and impressive track record in developing LED lighting solutions, the Space Force utilises the very latest technologies, high quality components and manufacturing techniques in order to deliver a reliable, premium performance light source.

A White Light for Every Application

The Chroma-Q Space Force is available as a variable white model 2,800K – 6,300K. Every unit is factory calibrated, to ensure consistent output and colour temperature.

Energy-Efficient

The Chroma-Q Space Force uses a fraction of the power required by conventional fixtures, while delivering all of the performance you require. Not only is the power consumption lower, so too is the heat produced - ensuring a cooler environment and lower air conditioning costs.

Convection Cooled

Using the same proven convection cooling technology found in other Chroma-Q LED fixtures - which eliminates the need for noisy cooling fans - the Space Force provides totally silent operation.

Long Life

The Chroma-Q Space Force utilises LED technology to ensure consistent long life performance - removing the need for costly regular maintenance associated with conventional fixtures.



Note: HANDHELD COLOUR METERS

Most Handheld Color Meters provide a limited measuring range for LED fixtures, which often results in inconsistent and unreliable data.

All photometric values listed in this document are based on testing and measurements conducted by certified independent laboratories with reference to the IES standards.

2. Operation

2.1 Unpacking the Units

The package includes 1 Space Force fixture, power connector and a Quick Start Guide. We recommend that you keep the original packaging in case the item needs to be returned.

2.2 Cabling

The fixture uses powerCon True 1 chassis connectors for power in and through. Use the provided connector to make a power feeder cable of the desired length and input connector configuration.

The maximum number of Space Force fixtures running off a single power input cable and using the power through connector is 5 at 120V AC or 10 at 230V AC if using a 12 AWG (3.3mm²) wire. Please refer to ANSI and AWG standards for the maximum data and power cable lengths.

Power cable wire colour schemes:

EU	North American	Connections	
Green and Yellow	Green	Earth (E)	Ground (Green)
Blue	White	Neutral (N)	Neutral (Silver)
Brown	Black	Live (L)	Hot (Gold)

The fixture uses XLR 5 pin input and through chassis connectors for ANSI E1.20 - 2010 RDM and USITT DMX512-A control. The XLR chassis are ground bonded.

XLR 5-pin Cable:

Pin#	Function
1	Common (Screen)
2	Data Minus
3	Data Plus
4	Spare Data Minus
5	Spare Data Plus

Important Notice: The use of an opto-splitter for DMX signal distribution is highly recommended when several fixture units are not plugged into the same power source.

2.3 Mounting

The fixture is equipped with brackets for bridle hanging applications. Standard yokes and low profile hanging brackets are available as optional accessory items.

Secure the fixture with a safety bond. A provision for a fixing hold is built into the fixture.

2.4 Control

The Space Force can be controlled through:

Manual Operation	The control panel at the rear of the fixture consists of the LEFT-HAND and RIGHT-HAND KNOBS and an LCD display
Input Cable	ANSI E1.20 - 2010 RDM-Remote Device Management over USITT DMX512-A control from an external console through an XLR-5 pin cable
INPUT RF	ANSI E1.20 - 2010 RDM-Remote Device Management over USITT DMX512-A control from an external console through a wireless connection

The fixture can operate as a standalone unit in manual control operation or be controlled remotely via the USITT DMX512 protocol. The control panel at the rear of the fixture consists of an LCD display, 2 rotary control knobs and 5 control buttons. The LCD display is backlit when you access the menus and turns off when left undisturbed for 5 seconds. The fixture can be remotely configured via ANSI E1.20-2010 RDM – Remote Device Management.

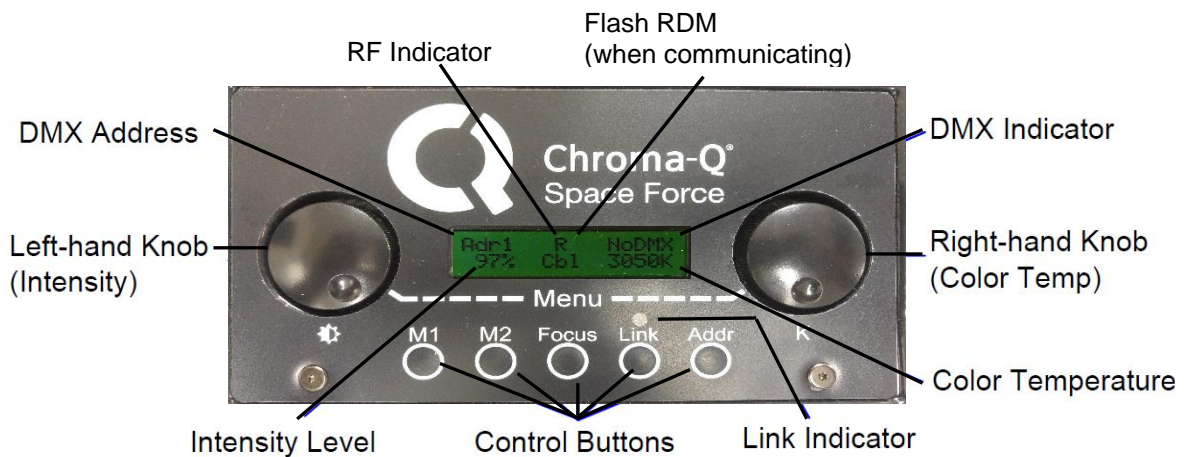

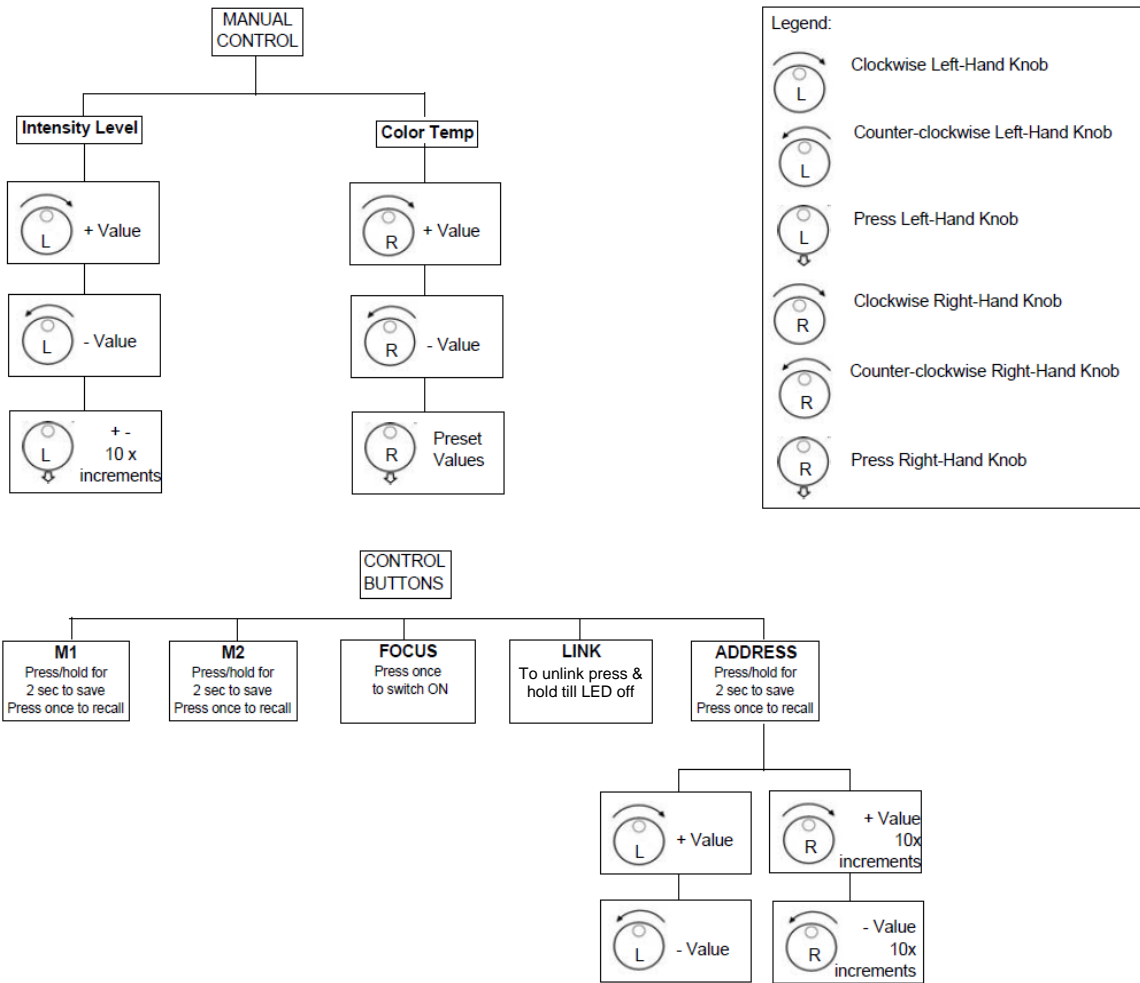

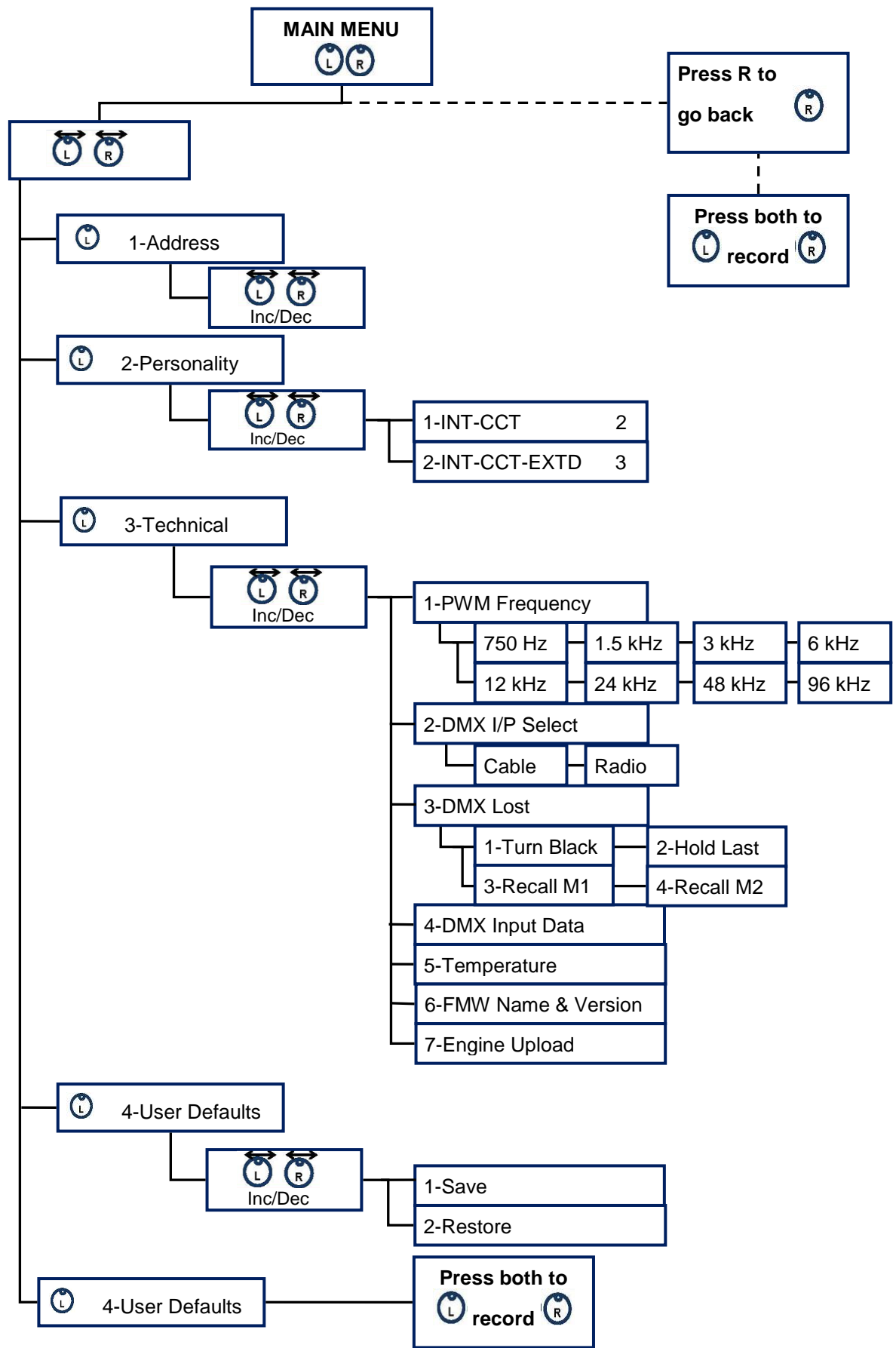



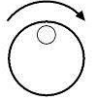
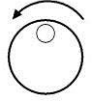

Manual Control in Standalone Operation:

LEFT-HAND KNOB sets the Intensity Level Output

	Rotate the Left-hand Knob clockwise to increase the Intensity Level from 0 – 100%
	Rotate the Left-hand Knob counter-clockwise to decrease the Intensity Level from 100 - 0%
	Press the Left-hand Knob to set the Intensity Level from 100% - 0% in increments of 10%.

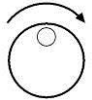
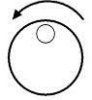
RIGHT-HAND KNOB sets the Color Temperature

	Rotate the Right-hand Knob clockwise to increase the Color Temperature value from 2800K – 6500K
	Rotate the Right-hand Knob counter-clockwise to decrease the Color Temperature value from 6500 – 2800K
	Press the Right-hand Knob to set the Color Temperature preset values: 6500K, 5600K, 4300K, 3200K, 3000K, 2800K

Control Buttons

M1	Stores a look, and recalls the saved look – factory default 3200K To save a look in M1, <ol style="list-style-type: none"> 1. In standalone or DMX operation, create a look 2. On the control panel, press and hold M1 until “SAVED” appears on the display To recall/playback a saved look in M1, <ol style="list-style-type: none"> 1. On the control panel, press M1 once 2. The unit goes to the saved look in M1
M2	Stores a look, and recalls the saved look – factory default 5600K To save a look in M2, <ol style="list-style-type: none"> 1. In standalone or DMX operation, create a look 2. On the control panel, press and hold M2 until “SAVED” appears on the display To recall/playback a saved look in M2, <ol style="list-style-type: none"> 1. On the control panel, press M2 once 2. The unit goes to the saved look in M2
Focus	Switches the fixture ON to the maximum output level for 30 seconds for a quick focus check or manual re-focus To switch Focus on, <ol style="list-style-type: none"> 1. Press Focus once 2. The preset output level switches on
Link	Unlinks from the previous wireless connections. Go to the section on Remote Wireless DMX Operation. The Link Indicator light flashes slowly when a previous wireless link is active. To unlink, <ol style="list-style-type: none"> 1. Press and hold Link for 2 – 5 seconds until the flashing light is off
Addr	Sets the DMX start address (see section on Remote DMX Operation)

Remote DMX Operation:

To set the DMX Start Address from the control button,

1. On the Control Panel, press the **Addr** button once, “Adr” on the top left of the display flashes
2. Use either the Left-hand and Right-hand Knobs to set the DMX start address,

LEFT-HAND KNOB:

- Rotate the Left-hand Knob clockwise to increase the value from 1 to 512 in increments of 1
- Rotate the Left-hand Knob counter-clockwise to decrease the value in increments of 1

RIGHT-HAND KNOB:

- Rotate the Right-hand Knob clockwise to increase the value from 1 to 512 in increments of 10
- Rotate the Right-hand Knob counter-clockwise to decrease the value in increments of 10

3. Press and hold the **Addr** button for 2 seconds to save the new DMX setting, “Done” and “SAVED” appears on the display.

To set the DMX Start Address from the Main Menu, see the following section Main Menu.

DMX Footprint: 2 channels

- 1st DMX Channel controls the Intensity Level adjustment
- 2nd DMX Channel controls the Color Temperature adjustment
- When setting Personality to” INT-CCT-EXTD”, a third DMX channel will be established to carry commands rather than light data from the console to the fixture.

Remote Wireless DMX:

To activate a wireless link,

1. Unlink the fixture – see instructions on page 9
2. Enable the INPUT RF from the Technical Menu
3. From the external transmitter, activate a link
4. The Link Indicator flashes fast to indicate the link in progress
5. The Link Indicator flashes slowly to indicate the link complete and active
6. The Link Indicator becomes solid ON if DMX is received over the wireless link

RDM Compliant:

The Space Force is an ANSI E1.20 - 2010 RDM-Remote Device Management compliant device which allows bi-directional control configuration, status monitoring and management through the wired and wireless DMX connection.

Parameter	Implemented	SET	GET	Value(s)	SFII Description
MANUFACTURER_LABEL			X	0x5370	Chroma-Q
DEVICE_MODEL_DESCRIPTION			X		SPACEFORCE_1
DEVICE_INFO	Yes	No	X		Sends the Device info
DMX_PERSONALITY	Yes	X	X	1	KL_PWM 750HZ
				2	KL_PWM 1500HZ
				3	KL_PWM 3000HZ
				4	KL_PWM 6000HZ
				5	KL_PWM 12000HZ
				6	KL_PWM 24000HZ
				7	KL_PWM 48000HZ
				8	KL_PWM 96000HZ
DMX_START_ADDRESS	Yes	X	X	1-511	DMX Start Address (foot print= 2:- [intensity:temperature])
IDENTIFY_DEVICE	Yes	X	No	1/0	Flashes ON/OFF for 30S/Reset flashing
RESET_DEVICE	Yes	X	No		Factory Defaults
SENSOR_DEFINITION	Yes	No	X		Engine Temperature
SENSOR_VALUE	Yes	No	X		Temperature in C°
SOFTWARE_VERSION_LABEL	Yes	No	X		PL1.65
STORE_MX	Yes	X	X	1	M1 (similar to LOOK 1)
				2	M2 (similar to LOOK 2)
RECALL_MX	Yes	X	X	1	M1 (similar to LOOK 1)
				2	M2 (similar to LOOK 2)
DEVICE_HOURS	Yes		X		Total device operation hours
DEVICE_POWER_CYCLES	Yes		X		Total number of device power cycles

New Control via DMX

When setting Personality to "INT-CCT-EXTD", a third DMX channel will be established to carry commands rather than light data from the console to the fixture. A command is a binary number that must be asserted on the third channel for at least 5 seconds to have it executed.

The changes made through DMX are not store in the fixture, this means that after a reboot the settings will revert back to values originally set in the fixture's menu.

However, it is possible to save these settings as new user default using the Save User Default DMX command (244-245).

See Control channel table.

RDM Functions

A. Chroma-Q Specific Functions

1. STORE MEMORY Mx

Description: Stores current light intensity and temperature to either memory (M1) or (M2) on flash.

Function: SET

Argument: one binary byte of value: 1 for M1, or 2 for M2

2. RECALL MEMORY Mx

Description: Restores light intensity and temperature previously stored in memory M1, or M2.

Function: SET

Argument: one binary byte of value: 1 for M1, or 2 for M2

3. UNLINK SPACEFORCE

Description: Unlinks TiMO RF module from the currently linked transmitter. This function can be sent in BORADCAT RDM mode causing all discovered SPACEFORCE fixtures to unlink, or to one fixture to unlink individual fixtures.

Function: SET

Argument: The string: UNLINK SPACEFORCE

4. SET PWM Freq (750,1500...96000)

Description: Sets PWM frequency.

Function: SET

Argument: String representing one of the eight set frequencies: 750, 1500, 3000, 6000, 12000, 24000, 48000, 96000.

5. GET PWM Frequency

Description: Reports current PWM frequency setting. Some of the RDM control PC applications report back a string with hex values. In this case, the reader should convert them to their numeric equivalents: 30='0', 31='1', 32='2',..., 39 = '9', and 20 = ' '. For example, "37 35 30 20 20" translates to: "750".

Function: GET

Argument: None

B. Standard RDM functions that require pass-in values

Although Standard RDM functions are well defined in the protocol, still some have been implemented with specific input and/or output parameters, as permitted. Following are these functions with specific parameters:

1. Identify Device

Description: Sets selected device to a blinking state for visual identification.

Function: SET

Argument: '1': Sets blink up to 30 seconds; '0': Stops blinking immediately. Any other argument will result in Not Acknowledged.

2. Device Label

Description: Sets and gets device label(string).

Function: SET, GET

Argument: None for GET. For SET, any alpha-numeric label up to 32 characters.

Fixes from Rv. 1.62

- a. Reset: DMX input settings are not changed on Reset.
- b. Focus: Activates all engines in the SPACEFORCE at the same time.
- c. Accessing Menu by pressing both dials has been adjusted to become easy.

- d. Adjust address pushbutton timing to work properly.
- e. Eliminated LCD back light flicker.

Mode 1 - INT-CCT

INT-CCT	Value	Function	Fade Status	Default Value
1		Intensity		
	0 - 255	Minimum → Maximum Intensity	Fade	0
2		Kelvin		
	0 - 255	Warm → Cold	Fade	128
	0	2800K		
	64	3200K		
	128	4400K		
	192	5600K		
255	6500K			

Mode 2 - INT-CCT-EXTD

INT-CCT-EXTD	Value	Function	Fade Status	Default Value
1		Intensity		
	0 - 255	Minimum → Maximum Intensity	Fade	0
2		Kelvin		
	0 - 255	Warm → Cold	Fade	128
	0	2800K		
	64	3200K		
	128	4400K		
	192	5600K		
255	6500K			
3		Extended Controls		
	0 - 255	* See Control channel table for details	Snap	0

Control channel table

Function name	Default	From	To	Description
<i>Values must be held for 5 sec before its function is activated</i>				
Control channel				
No Function		0	2	
Reserved		3	10	Reserved for future feature
Fade OFF		11	12	Switches light engine fade off. Useful for pulse operation.
Fade ON	X	13	14	Restores light engine fading.
Reserved		15	70	Reserved for future feature
PWM 750		71	72	Set PWM Frequency to 750
PWM 1500		73	74	Set PWM Frequency to 1500
PWM 3000	X	75	76	Set PWM Frequency to 3000
PWM 6000		77	78	Set PWM Frequency to 6000
PWM 12000		79	80	Set PWM Frequency to 12000
PWM 24000		81	82	Set PWM Frequency to 24000
PWM 48000		83	84	Set PWM Frequency to 48000
PWM 96000		85	86	Set PWM Frequency to 96000
Reserved		87	140	Reserved for future feature
Enable RDM	X	141	142	Enable RDM function
Disable RDM		143	144	Disable RDM function
Reserved		145	150	Reserved for future feature
DMX Lost fixture stay to the last state	X	151	152	When fixture loses DMX it will keep its last state
DMX Lost Fixture goes black		153	154	When fixture loses DMX it will go black
Reserved		155	156	Reserved for future functions
DMX Lost fixture to selected look		157	158	When fixture loses DMX it will Use the same look as stored in M1
Reserved		159	243	Reserved for future feature
Save as User Defaults		244	245	Take the current settings and make it the new default (except DMX address and DMX mode)
Restore User Defaults		246	247	Restore setting to saved user default (except DMX address and DMX mode)
Restore Defaults Settings		248	249	Restore setting to factory default (except DMX address and DMX mode)
No Function		250	255	

Main Menu

FUNCTION	ACTION
To access the Main Menu in the LCD Display	Press both LEFT-HAND and RIGHT-HAND KNOBS at the same time
To enter/select the menu	Press the LEFT-HAND KNOB once
To scroll through the menu items	Rotate the LEFT-HAND KNOB clockwise/counter-clockwise
To exit back to the previous menu or the main display	Press the RIGHT-HAND KNOB once
To save the selected menu item	Press and hold the LEFT-HAND and RIGHT-HAND KNOBS for 2 seconds and the display shows "SAVED"

⇒ 1-Address

- Sets the DMX start address

⇒ 2-Personality

- Personality selection, save and restore user defaults to the main menu. Two personalities are implemented
 - a. INT-CCT:
 - i. Footprint: Two channels (Address, Address+1).
 - ii. First channel: Light intensity; Second channel: Light temperature
 - b. INT-CCT-EXTD:
 - i. Footprint: Three channels (address, address+1, Address+2).
 - ii. First two channels are similar to (a.); the third channel is the Control (CTRL) channel. Commands (through DMX) that are placed on this channel for over 5 seconds get executed. The command list will follow in the "New Control via DMX" section.

⇒ 3-Technical

1– PWM Frequency	<p>The fixture can be set to various PWM frequencies to avoid flickering on camera:</p> <table border="1" data-bbox="555 275 1362 344"> <tr> <td>750 Hz</td> <td>1.5 kHz</td> <td>3 kHz</td> <td>6 kHz</td> <td>12 kHz</td> <td>24 kHz</td> <td>48 kHz</td> <td>96 kHz</td> </tr> </table> <p>Note: Dimming will be smoother at lower PWM frequencies.</p>	750 Hz	1.5 kHz	3 kHz	6 kHz	12 kHz	24 kHz	48 kHz	96 kHz
750 Hz	1.5 kHz	3 kHz	6 kHz	12 kHz	24 kHz	48 kHz	96 kHz		
2 – DMX I/P Select	<p>Enables the input connection:</p> <table border="1" data-bbox="555 485 1259 562"> <tr> <td>INPUT CABLE</td> <td>DMX from console via cable</td> </tr> <tr> <td>INPUT RF</td> <td>Wireless DMX from an external console</td> </tr> </table>	INPUT CABLE	DMX from console via cable	INPUT RF	Wireless DMX from an external console				
INPUT CABLE	DMX from console via cable								
INPUT RF	Wireless DMX from an external console								
3 – DMX Lost	<p>If the DMX control signal from an external source is not detected, various standalone output options can be selected:</p> <table border="1" data-bbox="660 680 1323 810"> <tr> <td>1 – OFF</td> <td>Fixture has no output</td> </tr> <tr> <td>2 – Hold Last</td> <td>Fixture holds the last valid DMX state</td> </tr> <tr> <td>3 – M1</td> <td>Fixture snaps to the saved look in M1</td> </tr> <tr> <td>4 – M2</td> <td>Fixture snaps to the saved look in M2</td> </tr> </table>	1 – OFF	Fixture has no output	2 – Hold Last	Fixture holds the last valid DMX state	3 – M1	Fixture snaps to the saved look in M1	4 – M2	Fixture snaps to the saved look in M2
1 – OFF	Fixture has no output								
2 – Hold Last	Fixture holds the last valid DMX state								
3 – M1	Fixture snaps to the saved look in M1								
4 – M2	Fixture snaps to the saved look in M2								
4 – DMX Input Data	DMX I/P channel values are displayed in decimal								
5 – Temperature	Internal temperature is displayed								
6 – FMW Name & Version	Firmware Name and Version are displayed								
7 – Engine upload	<p>Set this mode to enable the upload of LED engine software updates</p> <ul style="list-style-type: none"> Connect the fixture to the Uploader II Enable Engine LOAD from the Technical menu Initiate the upload from the Uploader II <p>(Refer to the Uploader II Quick Start Guide for details http://www.chroma-q.com/support/downloads.asp)</p>								

⇒ 4-User Defaults

- Provides two choices, Save and Restore. Save will store all the current set ups, including Address and Personality, into a user dedicated area on flash. Restore will bring that set up back.

⇒ 5-Reset Setting

- Resets all the control settings to the factory default

DMX Address	1
No DMX Present	Hold Last
PWM Frequency	3000 Hz
DMX Input	Input Cable

2.5 Thermal Performance

The internal cooling system of the fixture is by convection. It also features automatic protection that reduces the output when the internal temperature reaches the maximum limit due to extreme ambient conditions. See operating temperature range in the specification below.

3. Troubleshooting

Troubleshooting is a process of elimination. First, rule out the other field factors (i.e. bad connections, faulty cables and power supplies). For technical support and/or parts, please contact your selling dealer or the offices listed in this manual.

Symptom	Possible Cause	Solution
Fixture does not respond to DMX control.	<ul style="list-style-type: none">• Set to wrong or different DMX address.• Bad cable connecting DMX control and fixture.• Bad in/through connection between adjacent fixtures.• If DMX via RF link, the unit is not linked or linked to another transmitter• DMX input set incorrectly.	<ul style="list-style-type: none">• Check DMX address and Mode settings.• Check/replace DMX run from the console.• Unlink unit, then link from transmitter
Low LED output.	<ul style="list-style-type: none">• Internal temperature is over the limit.	<ul style="list-style-type: none">• Check unit temperature via RDM or on the LCD display.• Check area ventilation.
Flickering on camera.	<ul style="list-style-type: none">• Frequency set incorrectly.	<ul style="list-style-type: none">• Change PWM frequency.
Unit does not respond to RDM commands.	<ul style="list-style-type: none">• Being controlled via non-RDM compliant splitter.	<ul style="list-style-type: none">• Connect directly to RDM controller/gateway or use RDM enabled splitter.

4. Specification

4.1 Technical Specification

Product Code	CHSPFV Chroma-Q Space Force Variable w Bridle CHSPFVLR Chroma-Q Space Force Variable Bridle LumenRadio Installed
Net Dimensions (Without Fixings - Width x Height x Depth)	663mm x 203mm x 663mm / 26" x 8" x 26"
Net Weight (Without Fixings)	8 kg / 17.6 lb
Shipping Dimensions - Width x Height x Depth	737mm x 737mm x 254mm / 29" x 29" x 10"
Shipping Weight	11 kg / 24 lb
Power & Connections	
Power Supply	Built-in
Power Input Rating	100-240V AC 50-60Hz 400VA
Power Factor	0.9
Power Consumption	333W @ 120VAC, 331W @ 230VAC
Inrush Current	56A @ 120VAC, 82A @ 230VAC
Idle Power Consumption	18W @ 120/230VAC
Residual Current (max)	0.4 mA
Typical Power & Current	Measurements done with all LEDs at max. intensity. Measurements made at nominal voltage. Allow for deviation of +/- 10%.
Power Connectors In/Out	powerCON TRUE1
Data Connectors In/Out	XLR 5-pin
Control Protocol	ANSI E1.20 RDM over ANSI E1.11 USITT DMX 512-A,
Cooling System	Convection
Operating Temperature	0°C to 40°C
Construction	Powder-coated aluminum
Color	Black
IP Rating	*IP20
Approvals	CISPR 22:2008/EN55022:2010 (Class A), & CISPR 24:2010/EN55024:2010, FCC Part 15 Subpart B:2015, ICES- 003:2012; UL 1573:2003/R:2014-01, CSA C22.2 No. 160- M1983, IEC 60598
Medium White Lumen Output (combined)	up to 26,700
Optics	High efficiency diffuser
Beam Angle	60°
Beam Distribution	Symmetrical Direct Illumination
CCT	2,800 – 6,500K (+/-200K)
Sound Level	24.6 dB
Lamp Life	L70 at 50,000 hours

**For exact measurements please refer to the line drawings below



4.2 Drawings

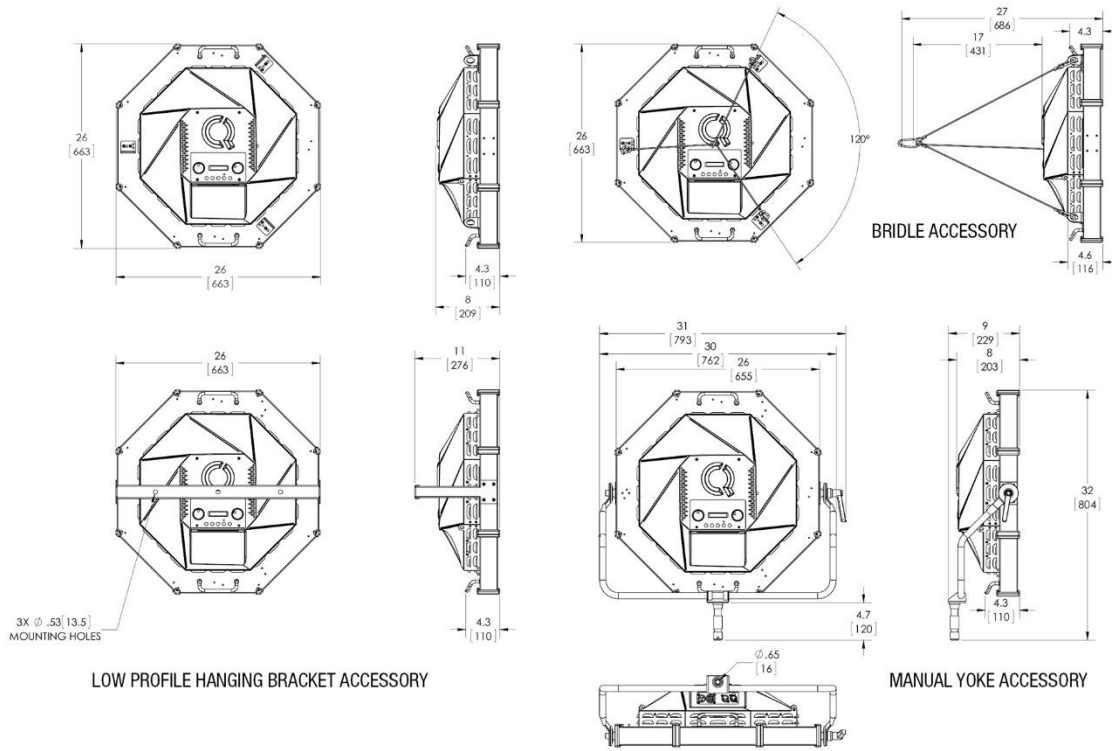

5. Accessories

CHSPFSY Chroma-Q Space Force Manual Yoke

CHSPFHB Chroma-Q Space Force Low Profile Hanging Bracket

CHSPFMS Chroma-Q Space Force Black Mini skirt

CHSPFSEC Chroma-Q Space Force Soft Egg Crate

CHSPFCK Chroma-Q Space Force Cyc Skirt/Silk

CHSPFSTK Chroma-Q Space Force Soft Target Kit - for use with a skirt Full, 1/2, 1/4, 1/8

CHSPFSL Chroma-Q Space Force Soft Lantern

CHSPFB Chroma-Q Space Force Bridle - included with fixture

CHSPFLR Chroma-Q Space Force LumenRadio Kit – User Installed

6. Maintenance

With care, the fixture requires little maintenance. However, as the unit is likely to be used in a stage environment, we recommend periodical internal inspection and cleaning of any resulting dust and cracked oil residue.

Do not spray liquids on the front or rear panel. If the front panel requires cleaning, wipe with a soft cloth. Use a vacuum cleaner to remove dust.