



AX3
LIGHTDROPTM

User Manual



1 CONTENTS

2	Package Contents.....	4
3	Declaration of Conformity	4
4	Safety and Handling.....	5
4.1	Bracket.....	5
4.2	Mounting options.....	6
4.3	Battery.....	7
4.4	Charging	7
4.5	AC Wiring	7
4.6	Diffusors.....	8
5	Specification	9
6	Troubleshooting	9
7	Operation	10
7.1	AsteraRGB Color Space	10
7.2	Ways to Control.....	11
7.3	Control By Infrared with ARC1	11
7.4	Control by the AsteraApp™	12
7.5	Control by Wireless DMX.....	12
7.6	Button.....	13
7.7	Status Display.....	13
7.8	Blue Mode / Show Static Color	15
7.9	Tap the Light (for AsteraApp™)	15
8	Using the Light with the AsteraApp™	16
8.1	Pair your Light with the AsteraApp™	16
8.2	Powerful Light Control.....	17
8.3	Change the Color	17
8.4	Create a Set	18
8.5	Targeting Lights	19
8.6	Changing The Effect	20
8.7	List of Effects	21
8.8	Chaser Effects in Deep	22
8.9	The Main Screen	23
8.10	Brightness.....	24
8.11	RUNTIME.....	24
8.12	Theft Alarm.....	25
8.13	Anti-Flicker.....	26
8.14	Enter and Leave Standby	27
8.15	DMX Settings.....	28
8.16	Dimmer Curve	31
9	DMX Profile Tables.....	32
1:	RGB (PIXELS = 1; STROBE = OFF)	32
2:	RGBS (PIXELS = 1; STROBE = OFF).....	32
3:	RGBAW (PIXEL = 1; STROBE = OFF)	32
4:	DIM RGB (PIXEL = 1; STROBE = OFF)	32
5:	DIM RGBW (PIXEL = 1; STROBE = OFF).....	33
6:	DIM RGBAW (PIXEL = 1; STROBE = OFF)	33
7:	RGB CCT DIM IND (PIXEL = 1; STROBE = OFF)	33
8:	RGBS (PIXEL = 1; STROBE = SINGLE)	34
9:	RGBWS (PIXEL = 1; STROBE = SINGLE)	34
10:	RGBAWS (PIXEL = 1; STROBE = SINGLE)	34
11:	DIM RGBS (PIXEL = 1; STROBE = SINGLE).....	35
12:	DIM RGBWS (PIXEL = 1; STROBE = SINGLE)	35
13:	DIM RGBAWS (PIXEL = 1; STROBE = SINGLE)	35
14:	RGB CCT DIM IND S (PIXEL = 1; STROBE = SINGLE)	36
15:	EFFECT MODE FIX.....	37



16: EFFECT MODE RGB	39
LEE Color Gels	41
10 Version History	45



Contact Information

Astera LED Technology GmbH

Stahlgruberring 36
81829 Munich
Germany

+49 89 2155253-0

Technical support

Europe: +49 89 21552253-1

America: +1-954-578-8881

Asia: +86 755 28237295

Email: service@astera-led.com



2 PACKAGE CONTENTS

- Lightdrop™
- 30° diffuser sheet (two holes)
- 120° diffuser sheet (three holes)
- Charger
- 3x Hook with M4 thread
- 4x Rubber foot
- Bracket
- Rubber socket plug
- Quick-start manual

3 DECLARATION OF CONFORMITY

This device complies with Part 15 of the FCC Rules. Operation is subject to the following two conditions:

- (1) this device may not cause harmful interference, and
(2) this device must accept any interference received, including interference that may cause undesired operation.**

FCC statement

Note: This equipment has been tested and found to comply with the limits for a Class B digital device, pursuant to part 15 of the FCC Rules. These limits are designed to provide reasonable protection against harmful interference in a residential installation. This equipment generates, uses and can radiate radio frequency energy and, if not installed and used in accordance with the instructions, may cause harmful interference to radio communications. However, there is no guarantee that interference will not occur in a particular installation. If this equipment does cause harmful interference to radio or television reception, which can be determined by turning the equipment off and on, the user is encouraged to try to correct the interference by one or more of the following measures:

- Reorient or relocate the receiving antenna.
- Increase the separation between the equipment and receiver.
- Connect the equipment into an outlet on a circuit different from that to which the receiver is connected.
- Consult the dealer or an experienced radio/TV technician for help.

EU Declaration of Conformity

These products comply with the RED (Radio Equipment Directive) of the European Union (2014/53/EC). This equipment meets the following conformance standards: ETSI EN 301 489-1 V1.8.1; ETSI EN 301 489-3 V1.4.1; ETSI EN 300 328 V1.8.1; EN 609 50.

ETL Listing

This product has been tested by Intertek laboratory and an ETL mark for USA and Canada has been granted.

The product fulfills the following standards: Information Technology Equipment Safety Part 1: General Requirements > Valid without technical revision: 01Jan2022< (UL 60950-1:2007 Ed.2 +R.14Oct2014); Information Technology Equipment Safety Part 1: General Requirements (R2016)>Valid without technical revision: 01Jan2022< (CSA C22.2#60950-1:2007 Ed.2+A1;A2)

4 SAFETY AND HANDLING

Before you operate this unit read the manual carefully. Always make sure to include the manual if you pass/rent/sell the unit to another user. Keep in mind that this manual cannot address all possible dangers and environments. Please use your own caution when operating. This product is for professional use only. It is not for household use.



Do not operate the unit in areas of high temperature conditions or under direct sunlight. It will cause abnormal function or damage the product.



Only qualified personnel may repair this product. Do not open the product housing.



Do not directly look into the light beam. It can cause harm to your eyes. Do not look at the LEDs with a magnifying glass or any other optical instrument that may concentrate the light output.

Use only Astera approved accessories to diffuse or modify the light beam.



The exterior surfaces of the light can become hot, up to 70°C (158°F) during normal operation. Ensure that accidental physical contact with the device is impossible. Allow all lights to cool before servicing.



A rechargeable lithium ion battery is built into this unit. Please avoid bumping or plunging, it may cause fire or explosion. Never store the battery when fully drained. Always recharge immediately when empty.

Make sure to fully charge all units before storing them. Partially charged batteries will lose capacity. Fully recharge every 6 months if not used.



Always charge with the carrying case open.

It is recommended to charge at a temperature between 0°C and 35°C



The light contains a lithium ion battery. Don't throw the unit into the garbage at the end of its lifetime. Make sure to dispose is according to your local ordinances and/or regulations, to avoid polluting the environment! The packaging is recyclable and can be disposed.



When mounting the light above people's heads, always follow local regulations. Always provide a second safety mounting, like a safety strip. Never mount it only by the magnet!

4.1 BRACKET

The AX3 Lightdrop™ is fitted with a multi-purpose bracket. This is beneficial for use as an up-light but also for mounting it to a Manfrotto Super Clamp. The main thread of the bracket is a 3/8" for which you can use for example a standard Manfrotto 037 stud.

The threads for the brackets are 1/4", so most camera accessories will fit. Even the bracket screws are equipped with a 1/4" thread at the outside.

4.2 MOUNTING OPTIONS

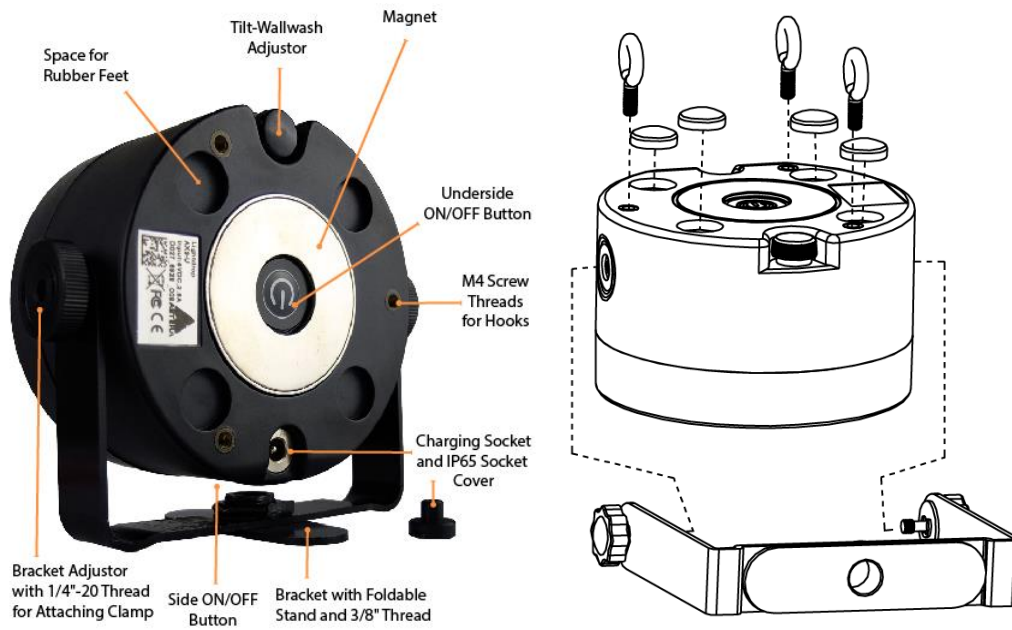

Position of M4 screw threads:

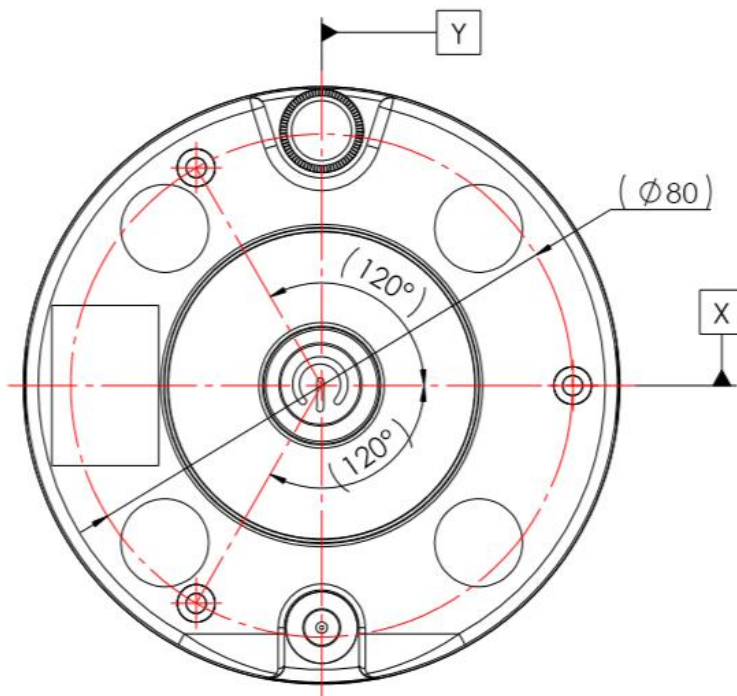

4.3 BATTERY

While running on battery, the light adjusts its output to meet the required minimum runtime. It can be set by AsteraApp™ between one and twenty hours.

After Reset Settings (chapter 7.6), it defaults to 5h.

The battery is specified to last for 300 full discharge cycles. Its runtime will have decreased to 70% by then. To increase the battery life it is recommended to recharge as early as possible and not let the light run until the battery is depleted.

If operated below 20°C, the battery runtime may be slightly shorter than predicted. This is also true if the lights are stored for a long time at cold temperature right before they are used.

The light is constantly monitoring the LED temperature and dims down the brightness if it exceeds 65°C. That ensures a save and long-live operation but in a hot environment the brightness might be slightly lower.

NOTE:

Always store the lights with full battery.

Depleted batteries must be recharged immediately, otherwise their performance will suffer.

ATTENTION:

The battery may be only replaced with an original Astera replacement battery.

4.3.1 STANDBY

By using the AsteraApp™, the light can be set to a special standby mode (chapter 8.14).

In that mode, its output is switched off, the CRMX receiver is powered down and it enters a state of low power consumption.

A full battery will supply the Lightdrop™ roughly 3 days in standby mode.

To leave standby mode, either do so by the AsteraApp™ or reset the light.

4.4 CHARGING

Charge the light immediately after use.

If charged in a carrying case, make sure it is open. It is recommended to charge the lights at an ambient temperature between 0°C and 35°C. A normal charge cycle will take five to seven hours, but may take much longer if the light is hot (blinking orange).

The light is designed to be charged while powered off. If it is connected to the charger and powered on, it may charge at reduced current if enough power is available and the battery temperature is below 45°C.

4.5 AC WIRING

The light has an automatic battery bypass switch, so it can safely be used wired, this will not cause wear to the battery.

4.6 DIFFUSORS

The diffusors can be seen below:



Flood Diffusor

This diffusor sheet will produce a beam angle of 30°.

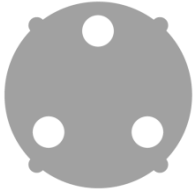

Wide-Angle Diffusor

This diffusor sheet will produce a beam angle of 120°.

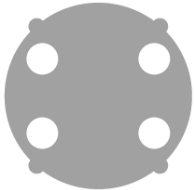

Wallwash Diffusor

This diffusor sheet will produce a beam angle of 17° x 46°. This diffusor is best suited for up lighting large flat surfaces (walls etc.).



Diffusor Dome

This diffusor dome is suited for use when the Lightdrop is inside translucent objects. It disperses the light more evenly, leaving no hot spots.

In order to **attach the diffusor**, align the four wings with the four cutouts on the Lightdrop, push into place and slide to secure. In order to **remove the diffusor**, do the opposite, and pull out using the finger holes provided.



5 SPECIFICATION

LED power:	15W
Illuminants:	1 x 15W RGBW Cree LED
Luminous Flux*:	420lm
Emittance*:	1200lx (at 2m; White 4000K)
Beam Angle:	13°
Input Voltage:	90-264V 47-63Hz / 5V 2.5A
Battery Runtime:	up to 20hrs (seamless runtime)
Wireless Module:	EU: 868.0-869.7 MHz US: 902-928 MHz 2.4 GHz
Operating Temperature:	0°C – 40°C 32°F – 104°F
Relative Humidity:	0%-100%
Size:	120mm x 59mm x 114mm, Diameter 96.4mm 4.7" x 2.3" x 5.1", Diameter 3.8"
Weight:	0.68 kg 1.4lbs
IP Rating:	IP65 (while rubber plug is in place)

* Typical Values

6 TROUBLESHOOTING

The fixture does not turn on.

The battery may be empty. Connect it to the AC and try again.

The fixture turns on and the display is on, but goes dark after showing the batter status shortly.

The fixture could be set to STANDBY mode, set to display black color or is operating in DMX mode and doesn't receive a valid signal. It is good practice to reset the fixture (Chapter 7.6) between setups.

The fixture is not working correctly - it does not display the color or effect chosen.

The fixture may still be operating under a previous setting. It is good practice to reset the fixture (Chapter 7.6) between setups.

After completing a reset, the fixture still cannot be controlled by the AsteraApp™.

Make sure the Radio PIN (Chapter 8.1) of the fixture and AsteraApp™ is the same and that it is paired with the AsteraApp™.

The fixture does not run long enough on battery.

The required runtime can be set. It defaults to 5h. To achieve a greater battery runtime, set the runtime to the required value. Alternatively, program the fixture to only display colors that use less power, such as Red, Green and Blue.

If the runtime is still too short, consider that it is reduced slightly if the battery is very cold.

The charger is connected but the fixture is not charging.

The battery may be fully charged. Refer to chapter 4.3.1 for more details. The fixture will only commence charging when its battery has a temperature of 45°C or less. Turn the fixture off and let it cool down; once cold enough, it will start charging.

7 OPERATION

7.1 ASTERARGB COLOR SPACE

The lights work with a specially optimized RGB color space, the AsteraRGB color space. It is designed to eliminate the need to control each color individually to display a certain color. Instead, the light calculates the optimum combination of all colors based on an RGB value. It considers each LED chip's temperature as well as an optimal color rendering.

Due to this, it is possible to reproduce colors with high accuracy. It's even possible to calculate an AsteraRGB representation for any CIE color. The easiest way to do this is with the AsteraApp™:

- Go to the color picker and add a new favorite color
- Go to favorite colors and edit it

The dialog on the right will open.

It allows you to find AsteraRGB values for a certain color temperature. S-RGB or CIE1931 values can be calculated to AsteraRGB by pressing the corresponding buttons.

The primaries of the AsteraRGB are defined as:

Red		Green		Blue	
x_R	y_R	x_G	y_G	x_B	y_B
0.7079	0.2920	0.1750	0.7200	0.1566	0.0177

White Point	
x	y
0.4917	0.4878



The light also includes the Dynamic Power Boost feature. It ensures that colors that consume less electrical power are boosted slightly, while power power-consuming colors are slightly compressed.

This maximizes the brightness while maintaining the desired battery runtime.

While controlling with the AsteraApp™, only RGB values can be set.

By DMX control, it is possible to control all colors separately. But it should be noted, that then temperature compensation is only available for Red, Green and Blue; White will experience temperature drift, its brightness will not be constant.

7.2 WAYS TO CONTROL

The light can be controlled in several ways:



Use Astera's ARC1 infrared remote control, point it at individual lights and press the desired effect.



The AsteraApp™ is an efficient way to quickly create a customized light show. It can group several lights together, address individual lights or groups of lights, and send complex effects with a user defined color palette to all lights in range. For additional information refer to chapter 8. Alternatively, the Astera ARC2 remote control can be used.



The light can also be controlled by CRMX wireless DMX, the built in receiver is compatible with all LumenRadio CRMX transmitters as well as W-DMX™ G2, G3, G4 and G4S transmitters (G4 and G4S in 2.4 GHz mode only).



You can also use an Astera ART3 Wireless DMX Transmitter to send DMX in the UHF frequency band, although CRMX is the recommended method.



Power the light on/off, set a static color or change its settings. (see chapter 7.8 for details on how to set a static color with the button)

CRMX is a trademark of LumenRadio AB

W-DMX is a trademark of Wireless Solution Sweden AB

7.3 CONTROL BY INFRARED WITH ARC1

The light can be controlled by the infrared remote control if:

- INPUT SELECT is set to AUTO or REMOTE CONTROL (refer to chapter 8.15.3).
- The light is currently NOT operated by DMX. If it is, only ON and OFF will work while INPUT SELECT is set to AUTO.



The ARC1 is very handy to switch several lights on or off at a time.



7.4 CONTROL BY THE ASTERAAPP™

Your light has a built in standalone engine. It can display static colors or replay a number of predefined effect patterns with a customizable color palette.

With the AsteraApp™ these effects can be created and be sent to the light by the built in UHF receiver. The effects are just triggered and then each light replays it autonomously until it receives a new effect.

Lights can be grouped into sets. This way they can be controlled separately and also effects can stretch over up to 32 lights.

Also, you can remotely adjust your lights settings, this eases DMX setup for example.

For more details refer to chapter 8.

7.5 CONTROL BY WIRELESS DMX

To pair your light to a CRMX or W-DMX™ transmitter, make sure that:

- Your light is not currently paired to a transmitter. To unpair do a Reset Settings (chapter 7.6).
- INPUT SELECT is either set to AUTO and the light is still in detect mode –or- INPUT SELECT is set to CRMX wireless DMX; for details refer to chapter 8.15.3.

Then press the button on your transmitter. After 10 seconds the light should be paired and react to wireless DMX signals. You can see if a light is paired in the AsteraApp.





Refer to chapters 8.15 about how to assign DMX addresses to your lights.

If you prefer to use an Astera ART3 wireless transmitter (sold between 2009 and 2015), set INPUT SELECT to ART3 DMX and refer to the ART3's user manual for details.

7.6 BUTTON



The light has two buttons. They are wired in parallel, so either of them can be used at the user's preference.

Press Button	Function
	Press the button shortly show the status display.
	Hold the button until the light turns on or off
	Blue Mode: hold the button, the light will first turn off, then back on again and it blinks blue. Chapter 7.8 explains the Blue Mode.
	Reset Settings: hold the button, the light will first turn off, then back on again and it blinks blue. Keep holding the button until blinking stops the light comes on red again.

NOTE:

Reset Settings also removes any CRMX / W-DMX pairing of the light.

7.7 STATUS DISPLAY

The lights main LED is double-used to display the battery status.

7.7.1 While Powered OFF

If the light is connected to the charger, the main LED either shows the battery status or is dark to indicate that charging has finished and the battery is full.

7.7.2 While Powered ON

Press the button and the main LED will show the battery- or charging-status for two seconds.

7.7.3 Battery Status

Battery Status



Less than 30mins runtime remaining; recharge



Over 30mins runtime have been used



Up to 30mins runtime have been used

Charging



Slow flashing; 0°-35°C charging at full current



Fast flashing; $\leq -0^{\circ}\text{C}$ or $\geq 45^{\circ}\text{C}$ fixture is under/overheating charging has stopped



Slow flashing; 36°-44°C charging at reduced current



Fast flashing; battery error

7.8 BLUE MODE / SHOW STATIC COLOR

In blue mode, the light shows a rapid blue blinking.



This mode is used to:

- Pair the light with an AsteraApp™
- Switch it to display a static color without the use of any remote control

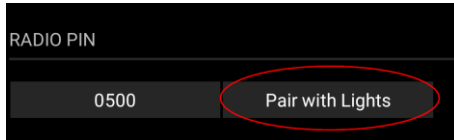
To pair the light, make sure it is in blue mode (see chapter 7.6), then press the “Pair with Lights” button in the AsteraApp™. More details on pairing can be found in chapter 8.1.



To set a static color, while in blue mode:

Press Button	Function
	Press the button shortly to cycle between the predefined colors. All previous STANDALONE settings are cleared to default and the INPUT SELECT is latched to STANDALONE. This is valid until the next power-up only. To make sure the light also shows a static color after the next power up, set INPUT SELECT to STANDALONE and not AUTO.
	To exit Blue Mode and latch the chosen color, hold the button until the blinking stops.

7.8.1 Predefined Colors

Color	Red	Green	Blue
RED	255	0	0
ORANGE	255	107	0
YELLOW	255	160	18
GREEN	0	255	0
CYAN	0	255	224
BLUE	0	0	255
VIOLET	127	84	255
PINK	255	53	119
2700K	255	166	70
3200K	255	178	89
4000K	255	193	115
5500K	255	211	150
6500K	255	219	167

7.9 TAP THE LIGHT (FOR ASTERAAPP™)

During certain tasks, like setting up the DMX or creating a set, the AsteraApp™ asks to tap a light.

In that case, the light will flash white shortly every two seconds.

Press Button	Function
	Press the button shortly to “tap the light”. The light will confirm with three bright white flashes. The new configuration, like DMX address, set association ect. is latched.

8 USING THE LIGHT WITH THE ASTERAAPP™

The button only allows a basic operation of the light. To gain full control over all features, the AsteraApp™ should be used.

The AsteraApp™ is an efficient way to quickly create a customized light show. It can group several lights together, address individual lights or groups of lights, and send complex effects with a user defined color palette to all lights in range.

Additionally, it can be used to adjust the lights settings remotely.

The AsteraBox™ is needed to interface your Android device with the lights. It communicates to the Android device by Bluetooth and controls the lights by UHF.

8.1 PAIR YOUR LIGHT WITH THE ASTERAAPP™

The connection is secured by a 4 digit Radio PIN. Only if the lights PIN matches the AsteraApp™ PIN, lights are controllable.

The pairing process transmits the Radio PIN from the app to the light and stores it there.

1. Choose a unique Radio PIN in the app.
2. Switch the light into blue mode, see chapter 7.6.
3. Press the "Pair with Lights" button in the AsteraApp™.

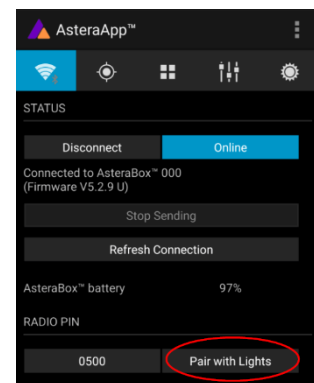

8.2 POWERFUL LIGHT CONTROL

Your light has a built in standalone engine. It can display static colors or replay a number of predefined effect patterns with a customizable color palette.

With the AsteraApp™ these effects can be created and be sent to the light by the built in UHF receiver. The effects are just triggered and then each light replays them autonomously until a new effect is sent.

Lights can be grouped into sets. This way they can be controlled separately and also effects can stretch over up to 32 lights.

8.3 CHANGE THE COLOR



On the AsteraApps main screen, press "Just Red".

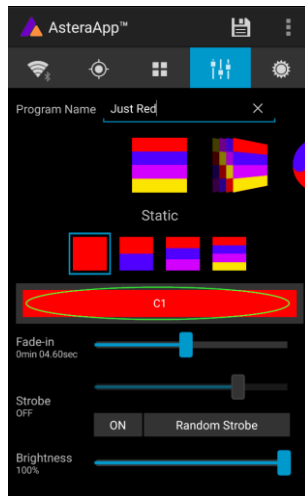

Once in the editor, press "C1".

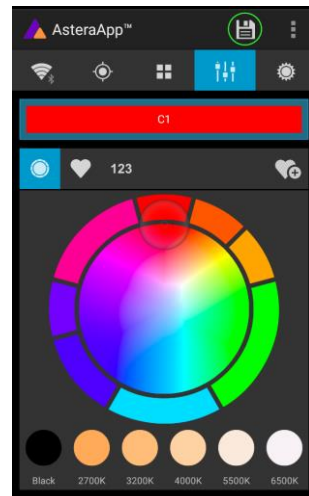

Now the lights color can be changed.

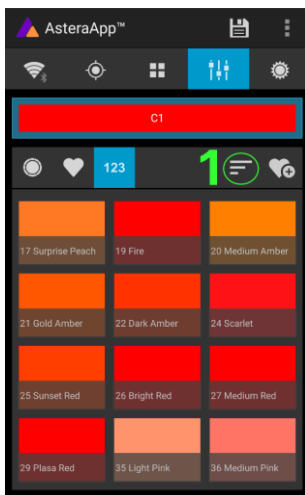

The "123" button offers common color gels. Hit the sort button to sort by color or number (1).

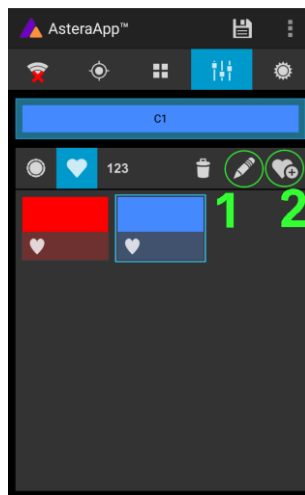

To add a color to the favorites, press (2). To edit an existing favorite color, select it and press the pen (1).

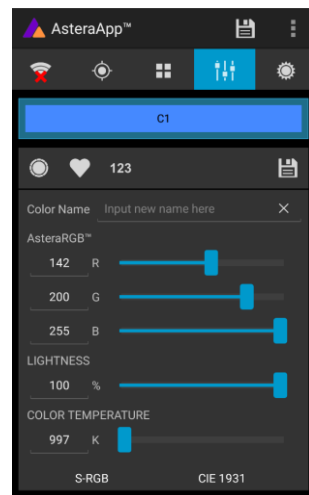

The editor will open. RGB values can be adjusted directly. Also a color temperature can be converted to RGB.

8.4 CREATE A SET

Before the more powerful effects can be reviewed, it is recommended to create a Flow-Set first.

Each light can be assigned to one set. Two types of sets are available:

8.4.1 SYNC SET

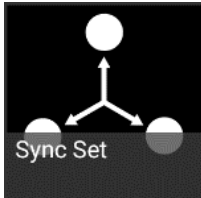

All lights that are assigned to a Sync-Set can be controlled together. They will do exactly the same.

CREATE A SYNC-SET:



On the AsteraApp™ main screen, first press the Targets button (1) and then the "+" sign (2) to add a new target.

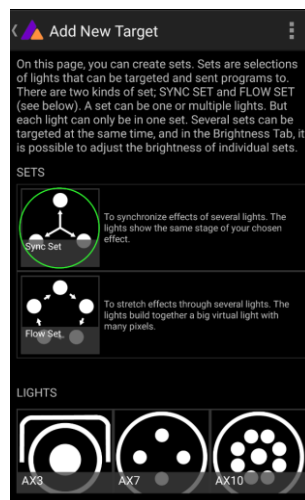

Choose "Sync-Set".

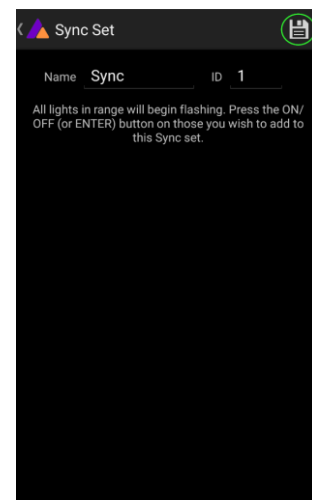

Now all lights will flicker every two seconds. Tap your light to add it to the set (chapter 7.9). Additionally, the name of the set can be customized. When finished, press the save button.

8.4.2 FLOW SET

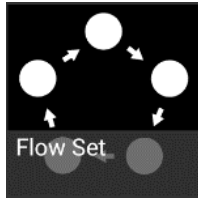

By using a Flow-Set, lights can also be controlled together. But additionally, they are assigned to positions inside the Flow-Set and so form a virtual light with several pixels. All effects, like a running light, are stretched over this virtual light.

CREAT A FLOW-SET:



On the AsteraApp™ main screen, first press the Targets button (1) and then the "+" sign (2) to add a new target.

Then choose "Flow-Set".

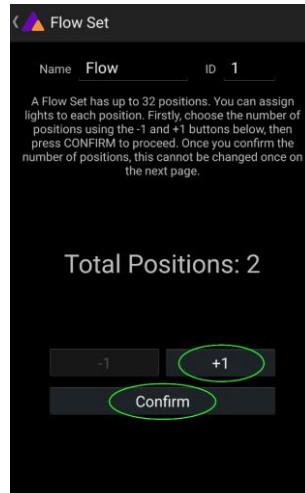

Each flow set can have up to 32 positions. Once the correct number is entered, press "Confirm".

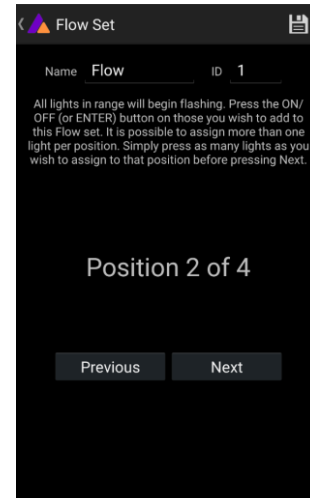

Now your lights will flicker every two seconds. To add a light to the currently shown position of this set, press its button. Walk through the positions by "Previous" and "Next" and assign your lights. When finished, press the save button on top.

8.5 TARGETING LIGHTS

Once you have created a set, you may now choose to control it. By default "All lights" are targeted. That includes all sets.

It is possible to target more than one set at a time.

NOTE:

Even while targeting „All Lights“ the Flow-Sets position arrangements persist. The lights still form a virtual big light of several positions.

To modify, delete or arrange targets, use the pen button (1).

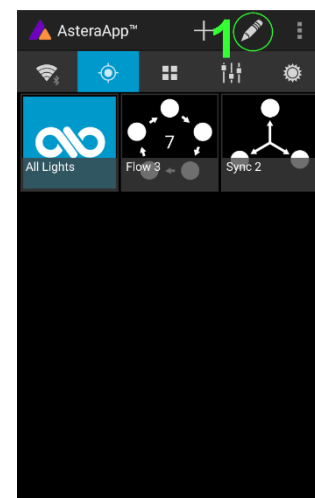

8.6 CHANGING THE EFFECT



On the AsteraApp™ main screen, press “Wedding” (1), then enter the editor (2).

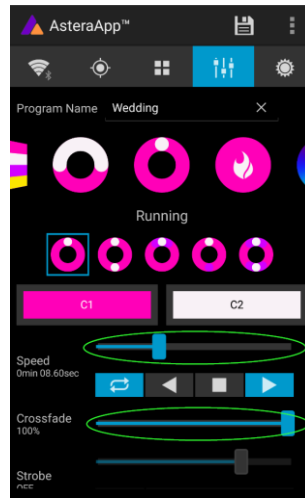

Set “Crossfade” to 0% and “Speed” to around 2 seconds. You should see a clean running light now. The White light will run over a pink background.

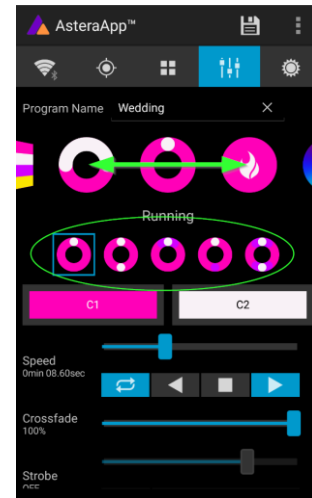

The effect can be changed by sliding the effect picker and choosing a sub-effect below it. Again the colors can be adjusted, too.

After the effect is adjusted, it may be saved back to the main screen by pressing the save button.

AN EFFECT CAN BE HIGHLY CUSTOMIZED:



The speed tells how long it will take for the effect to complete one cycle.



The crossfade tells if the light will fade from step to step. If it is set to 0% an immediate change is visible. If set to 100% the changes will be soft.

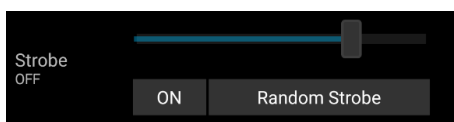









Stroboscope effect can be enabled and seamlessly adjusted in speed. Additionally, three random stroboscope options are available: slow, medium and fast.

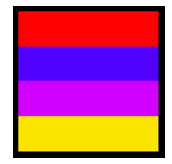

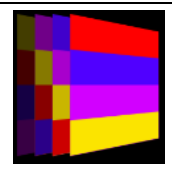
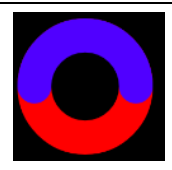
Each effect can be adjusted in brightness as well.

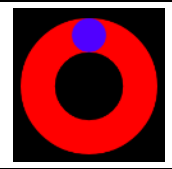
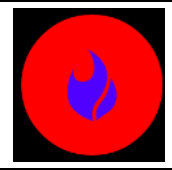
8.7 LIST OF EFFECTS

The effects patterns are pre-defined and cannot be modified by the user. They are pre-programmed inside of each light. Still they can be parameterized. These are available:

	<p>A static color is displayed. There are also options that show two, three or four static colors at a time. The Flow-Set is then divided into several parts of equal length.</p> 
	<p>Fading colors. The four defined colors are displayed one after the other. The setup fade is applied between them. Again, the Flow-Set can be split in up to four segments.</p>
	<p>From both sides of a Flow-Set, the color changes position by position from C1 to C2. Once the whole Set is C2, it changes back to C1 in the same way.</p>
	<p>The color of the Flow-Set changes position by position. After all positions show the same color, a new cycle is started.</p>
	<p>Several variations of running lights are available.</p>
	<p>The Fire effect shows a random flickering effect. The background color and the color of the flickering effect can be adjusted.</p>
	<p>The rainbow effect shows a color change through all colors. Only its speed can be adjusted.</p>
	<p>Chaser effects provide an efficient means to create dancefloor lighting. The static chaser exchanges the color of the lights according to the tapped-in beat. The colors are randomly chosen. The effect can be adjusted to show up to 4 different colors at a time.</p>
	<p>The Moving Chasers overlay the static chaser by a second movement of the four displayed colors over the available positions of a Flow-Set. This gets mostly interesting if the Moving Strobe is chosen. Then, only some of the positions strobe and they are moving. So the strobe effect moves over the Flow-Set.</p>
	<p>When using the Chaser With Background, additionally a color can be selected that is mostly used, the background color.</p>

8.8 CHASER EFFECTS IN DEEP

To display chaser effects it is recommended to setup a Flow-Set with a multiple of four positions. This way they will be shown best. Those four positions could then be arranged in the corners of a dance floor for example.

Use the tap-sync button to tap the beat of the music; the Chaser Effects will base their color changing on that beat then.

The Chaser Effects offer additional controls



The Emphasis adjusts the way the colors are exchanged by the chaser:

Emphasis	Effect
-2	The four colors of the palette are exchanged one by one. Every beat changes only one color.
-1	Same as "-2", but the color change is animated with the color-wheel effect; it mimics the color change of a traditional color wheel, showing intermediate colors during the change.
0	All four colors are exchanged on every beat.
1	Same as "0", but the color wheel effect is added.
2	Same as "0", but on the fourth beat, all colors go black. They come on again on the next beat.
3	Same as "0", but all colors go black on every second beat. This setting produces a strong on-off effect in sync with the beat.



The softness influences the fading between colors that happens on every beat. 0% will generate a hard change of the colors, while 100% makes them fade very slowly.



A random button is added to the color bar. If it is latched, random colors are chosen on every beat. If not (like in the above picture), then the colors are always chosen randomly from the color pallet of four. This is useful to intentionally narrow down the color choice. Nice effect can be generated by setting some of them to black.

8.9 THE MAIN SCREEN

Here each program is represented by a tile. Those tiles can be edited and freely positioned. Several pages of tiles are available.

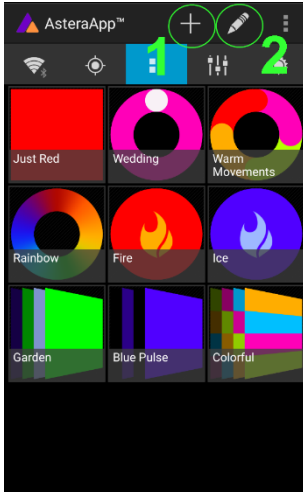

To move or delete a file, press the pen icon (2). A popup will show the available actions.
To add a new program tile, press the "+" icon (1).

While adding a file, either a default "Static Red" or the currently running program can be selected. Additionally, special function tiles are available.

8.9.1 Function Tiles

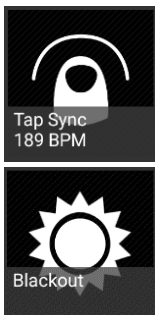

Tapping this tile several times to the beat will let the Chaser Effects change their colors to the beat. A chaser effect has a dancer symbol on the tile.



This button can be used to quickly blackout lights. The currently set target must be observed, as the blackout function will only affect the currently targeted lights.

8.10 BRIGHTNESS

Additionally, to each programs brightness slider mentioned in chapter 8.6, a master brightness control is available.

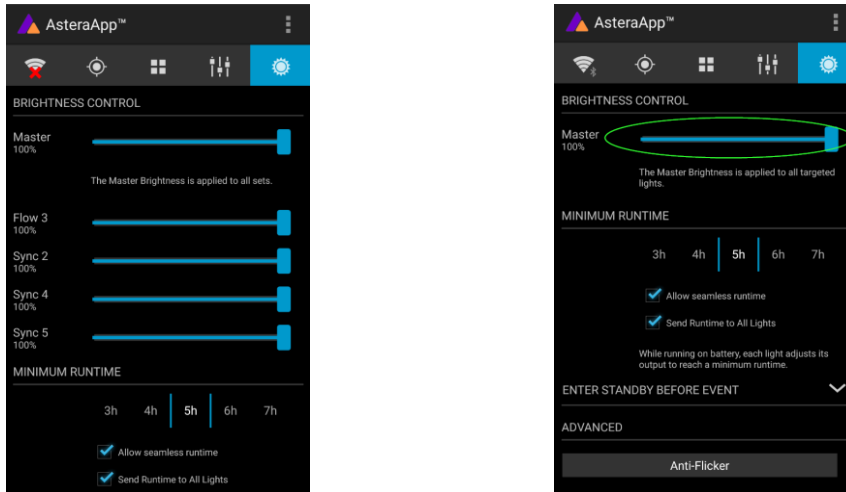

As soon as more than one Set is created and at least one set is currently targeted, a sub-master for each Set is shown.

Otherwise, only one slider is available. It controls the brightness of all currently targeted lights.

8.10.1 Set Sub-Masters

Each Set has its own brightness slider. Additionally, there is a master slider that controls the brightness of all Sets simultaneously. This is very similar to the group brightness control of common lighting desks.

NOTE:

The Set-Masters are only shown if:

- More than one Set has been created before
- Only Set-Targets are currently selected. Selecting any other type of target, like "All Lights" will hide the Set-Masters. This is necessary to avoid that one lights gets redundant brightness information; it would flicker constantly between different brightness levels.

8.11 RUNTIME

The light is able to adjust its power to meet a certain runtime on battery. The runtime is always calculated for a full battery.

Example:

If the light is required to light during an eight hour event, and one hour of setup time is scheduled, then the runtime should be set to nine hours immediately after the first power up.

Please note, that the light should not be stored below 20°C before an event, otherwise the runtime might be shorter than calculated.

More details on the built-in battery can be found at chapter 4.3.

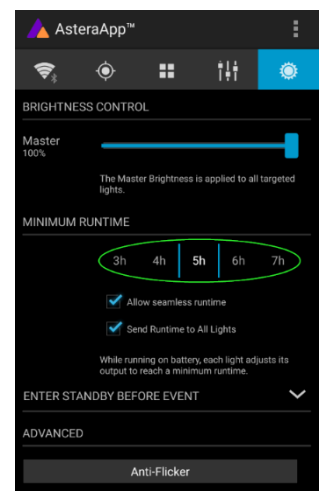

8.12 THEFT ALARM

Your light is equipped with a theft alarm. A motion sensor in the light detects when it is moved/taken away and a small siren will sound to deter potential thieves.

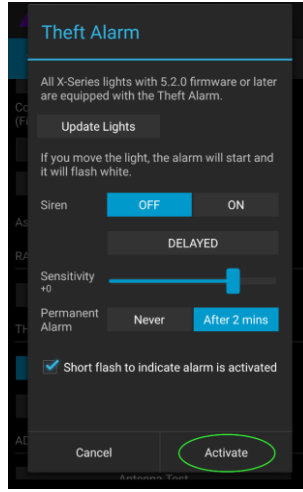
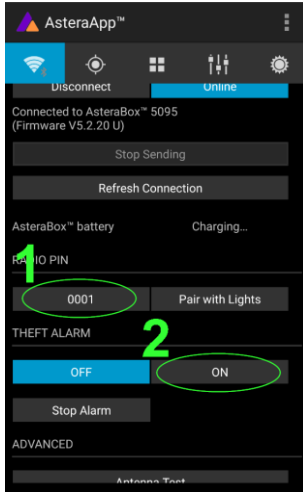

First make sure your Radio PIN is different from 0000. See chapter 8.1 how to change it. Then press the "ON" button.

Press "Activate". All targeted lights will flash shortly to indicate that they are now armed.

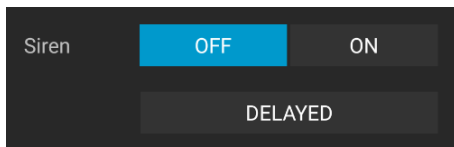

If the siren is set to DELAYED, it sounds only if the alarm persists for more than 6 seconds. The ON setting makes it sound immediately, while the OFF setting mutes it always.

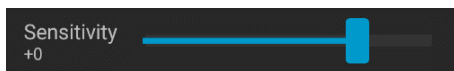

The sensitivity can be adjusted to meet your environment. A lower value makes a false alarm more unlikely.

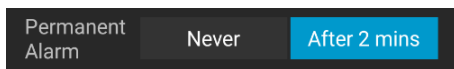

In case a potential thief is taking the light away while ignoring the alarm, he will most likely cause alarm events for more than 2 minutes in a row. In that case, the alarm can be set to become permanent. Then it won't stop, even if the light is placed down again. It will run until the battery is empty, rendering the light useless for the thief.

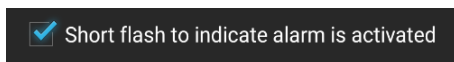

In some applications it is not desirable to have the lights flashing while the alarm is enabled or disabled. It can be disabled by this option easily.

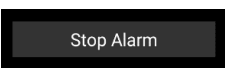

The alarm can be silenced without turning it off by pressing this button.

NOTE:

To turn the alarm off again, an AsteraApp™ with the same Radio PIN must be used. Do not forget your Radio PIN! Otherwise, your light cannot be used normally anymore.

8.13 ANTI-FLICKER

The PWM refresh rate of this light is 599.4 Hz by default. This frequency can be freely adjusted between 200 Hz and 1205 Hz to fit different camera's frame rates.

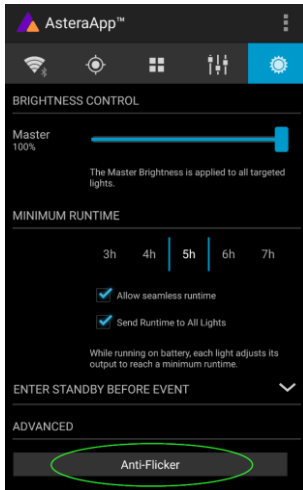

Make sure you have targeted the lights you wish to adjust (chapter 8.5). Then press the "Anti-Flicker".

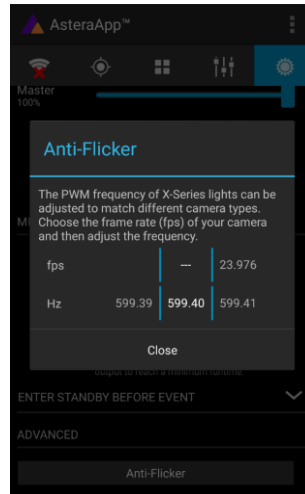

Slide the "fps" to adjust to default values for a framerate. Slide the "Hz" to fine-adjust.

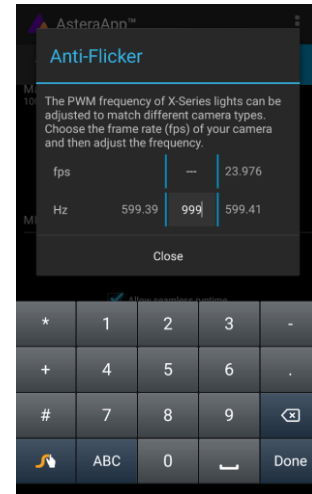

Press the highlighted frequency to enter a custom value between 200 and 1205 Hz.

NOTE:

The Anti-Flicker adjustment is preserved in case the lamp is powered off. It is set back to the default 599.4Hz once a Reset Settings (chapter 7.6) is done. The adjusted frequency is used no matter what input source is currently active. Also during DMX operation.

8.14 ENTER AND LEAVE STANDBY

The standby is intended to be used between setup and event (see chapter 4.3.1). After setup is completed, all lights may be switched to standby mode and woken up later when the event starts. This ensures that no battery runtime is wasted. This can be either done manually or automated.

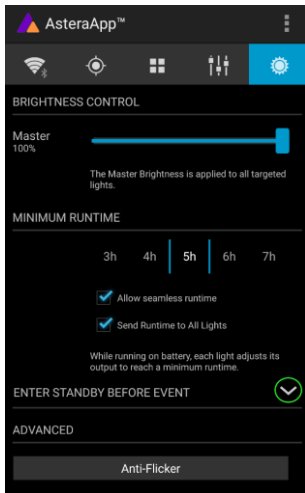

Press the small arrow to open the standby menu.

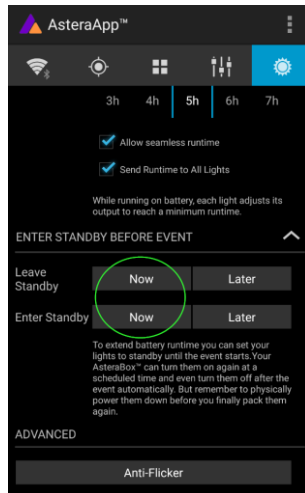

By pressing the "Now" buttons, standby can be switched on or off for all currently targeted lights.

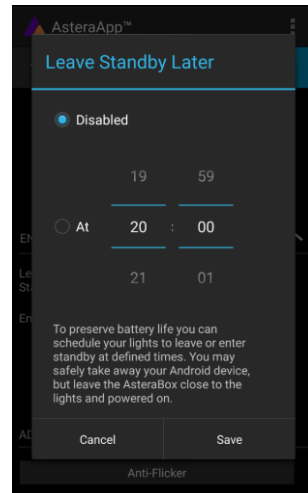

Any of the "Later" buttons will require a time to be set. The standby will be scheduled to the specified time.

NOTE:

While you are using the "Now" function, only those lights that are currently targeted are addressed (see chapter 8.5 how to target lights).
The "Later" function always sends to the "All Lights" target!

NOTE:

To check if the light is completely powered off or only in standby mode, press the power button shortly. If it stays dark it is powered off.

8.15 DMX SETTINGS

To efficiently use the light with DMX, some settings can be adjusted by the AsteraApp™.

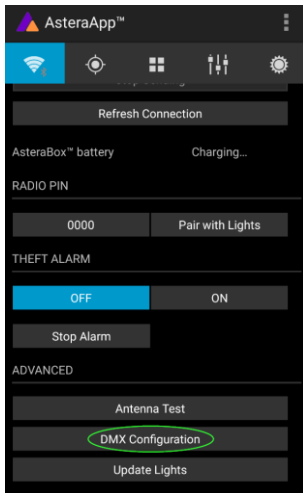

Press the “DMX Configuration” button.

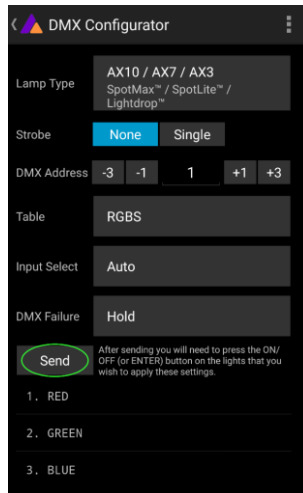

Adjust all settings to your requirements, then press “Send”.

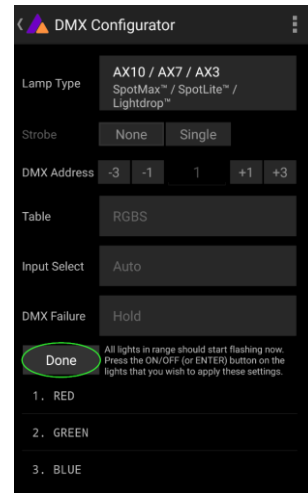

Your lights will start to flicker. Tap the lights you wish to setup (chapter 7.9). Then press “Done”.

8.15.1 DMX Address

The address can be either entered directly, or adjusted by the “+” and “-” buttons.

8.15.2 DMX Failure

It can be set what the lights should do when the DMX signal is lost.

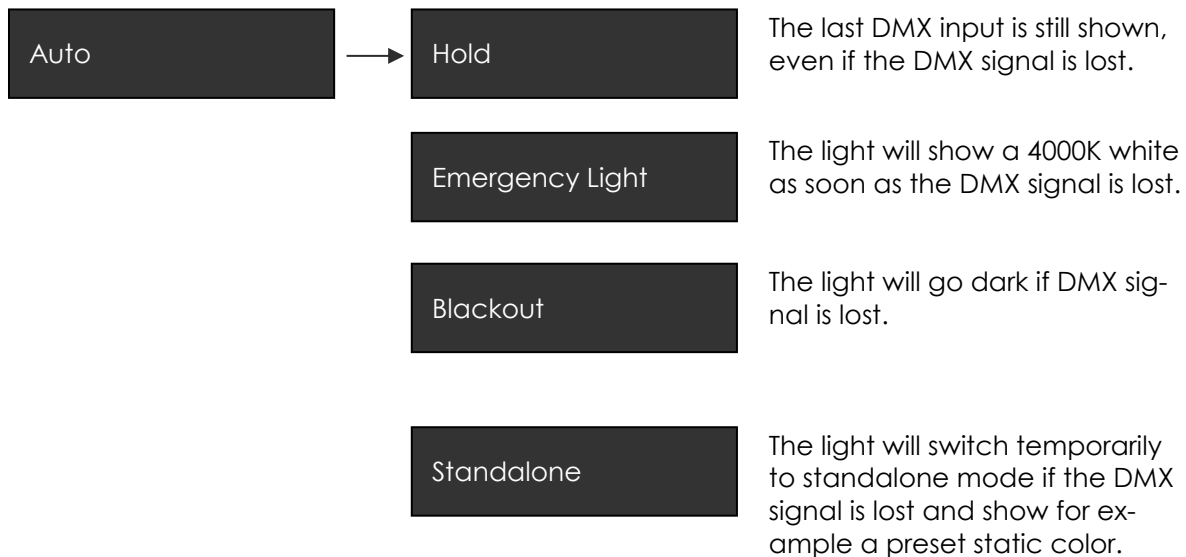

8.15.3 Input Select

The light accepts several input sources. By default, it is set to AUTO. In this mode, it listens to all sources, and the first source that becomes active is latched. Once a source is latched, the light will not listen to any other source anymore.

This latched source is cleared by powering down the light or changing the INPUT SELECT manually.

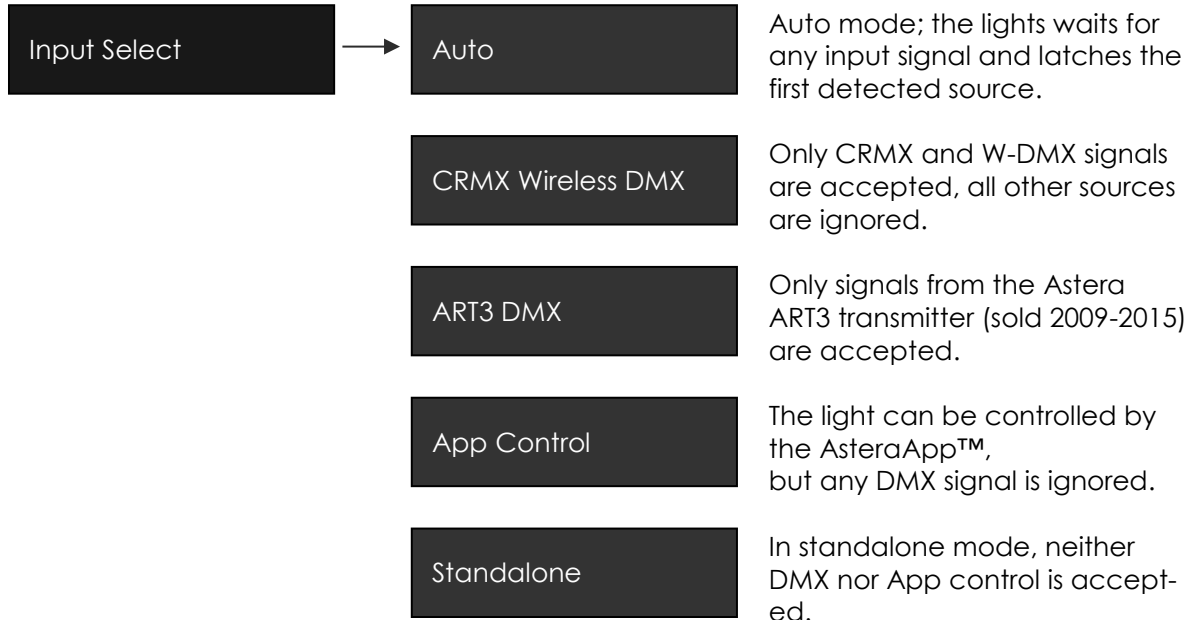

The following table shows what sources are accepted for each setting:

Source	INPUT SELECT									
	Auto, none latched	Auto, Standalone latched	Auto, App Control latched	Auto, ART3 DMX latched	Auto, CRMX wirel. DMX latched	Standalone	App Control	ART3 DMX	CRMX wireless DMX	
AsteraApp™: change colors	●		●				●			
AsteraApp™: STANDBY, RUNTIME, ALARM	●	●	●	●	●		●			
AsteraApp™: DMX Settings	●	●	●	●	●		●	●	●	
ART3 DMX	●			●				●		
CRMX Wireless DMX	●				●				●	
Infrared Remote	●	●	●	●	●		●			
The Light's Control Panel	●	●	●	●	●	●	●	●	●	

HINT:

To avoid the light automatically latching onto CRMX while you want to control it by remote control, please unpair it first (chapter 7.6). As soon as the remote control is latched, the CRMX receiver will no longer accept pairing requests.

8.15.4 DMX Profiles

A number of DMX Profiles can be selected.



Each of the profiles can optionally contain a strobe channel. It can be disabled, defined as single strobe for the complete fixture or as multiple strobe where each pixel segment has its individual strobe.



For programming purposes, we have included an extensive list of the DMX Profiles in Chapter 9.

8.15.5 DMX Channel Assignment

The current channel assignment can be always reviewed in the lower part of the screen. It is automatically calculated based on the setting of DMX Profile and Strobe.

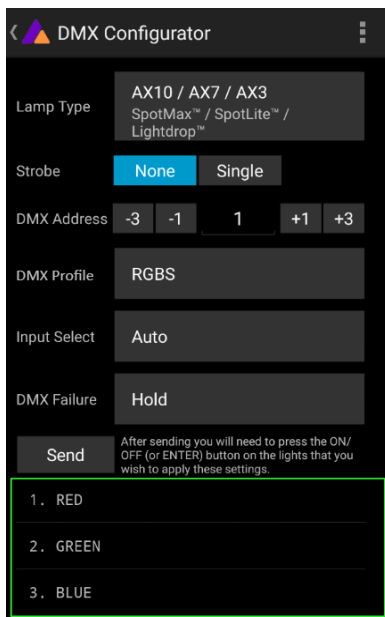



8.16 DIMMER CURVE

The dimmer curve sets how the light responds to intensity levels and changes. Most important, setting the right dimmer curve avoids stepy dimming response.

Several curves are available. By default, the "STANDARD" curve is active.

Name	Intended use	Features
FAST	For Pixel mapping and similar applications	Totally unfiltered response
STANDARD	Good compromise between response and smoothness	Fits most applications
HALOGEN	When slow and smooth dimming is required	Very smooth response, emulating a halogen light
THEATER	For theater stages	Very smooth response and increased dynamics. Some colors are darker.
TV	For TV sets and shows	Faster but still smooth dimming. Less blue light due to white point of 6500K. Less blue light. Increased dynamics. Some colors are darker.

9 DMX PROFILE TABLES

1: RGB (PIXELS = 1; STROBE = OFF)

CHANNEL	VALUE	PERCENTAGE	FUNCTION
1	0 - 255	0 - 100	Intensity Red (0% --> 100%)
2	0 - 255	0 - 100	Intensity Green (0% --> 100%)
3	0 - 255	0 - 100	Intensity Blue (0% --> 100%)

2: RGBS (PIXELS = 1; STROBE = OFF)

CHANNEL	VALUE	PERCENTAGE	FUNCTION
1	0 - 255	0 - 100	Intensity Red (0% --> 100%)
2	0 - 255	0 - 100	Intensity Green (0% --> 100%)
3	0 - 255	0 - 100	Intensity Blue (0% --> 100%)
4	0 - 255	0 - 100	Intensity White (0% --> 100%)

3: RGBAW (PIXEL = 1; STROBE = OFF)

CHANNEL	VALUE	PERCENTAGE	FUNCTION
1	0 - 255	0 - 100	Intensity Red (0% --> 100%)
2	0 - 255	0 - 100	Intensity Green (0% --> 100%)
3	0 - 255	0 - 100	Intensity Blue (0% --> 100%)
4			No Effect
5	0 - 255	0 - 100	Intensity White (0% --> 100%)

4: DIM RGB (PIXEL = 1; STROBE = OFF)

CHANNEL	VALUE	PERCENTAGE	FUNCTION
1	0 - 255	0 - 100	Dimmer (closed --> open)
2	0 - 255	0 - 100	Intensity Red (0% --> 100%)
3	0 - 255	0 - 100	Intensity Green (0% --> 100%)
4	0 - 255	0 - 100	Intensity Blue (0% --> 100%)

5: DIM RGBW (PIXEL = 1; STROBE = OFF)

CHANNEL	VALUE	PERCENTAGE	FUNCTION
1	0 - 255	0 - 100	Dimmer (closed --> open)
2	0 - 255	0 - 100	Intensity Red (0% --> 100%)
3	0 - 255	0 - 100	Intensity Green (0% --> 100%)
4	0 - 255	0 - 100	Intensity Blue (0% --> 100%)
5	0 - 255	0 - 100	Intensity White (0% --> 100%)

6: DIM RGBAW (PIXEL = 1; STROBE = OFF)

CHANNEL	VALUE	PERCENTAGE	FUNCTION
1	0 - 255	0 - 100	Dimmer (closed --> open)
2	0 - 255	0 - 100	Intensity Red (0% --> 100%)
3	0 - 255	0 - 100	Intensity Green (0% --> 100%)
4	0 - 255	0 - 100	Intensity Blue (0% --> 100%)
5			No Effect
6	0 - 255	0 - 100	Intensity White (0% --> 100%)

7: RGB CCT DIM IND (PIXEL = 1; STROBE = OFF)

CHANNEL	VALUE	PERCENTAGE	FUNCTION
1	0 - 255	0 - 100	Intensity Red (0% --> 100%)
2	0 - 255	0 - 100	Intensity Green (0% --> 100%)
3	0 - 255	0 - 100	Intensity Blue (0% --> 100%)
4	0 - 4 4 - 255	0 - 1.5 1.6-100	Color Temperature (CCT) No effect Display color temperature Formula: $CCT = 2000 + 20 * DMX-Value$ Example: 50 --> 3000K 100 --> 4000K 150 --> 5000K <i>*CCT overwrites the RGB setting</i>
5	0..255	0 - 100	Dimmer (closed --> open)
6	0..1 2..255	0 - 0.4 0.8 - 100	LEE Color Gel No effect Display LEE color gel (full list on page 41) <i>*LEE Color Gel overwrites both, RGB and CCT</i>

8: RGBS (PIXEL = 1; STROBE = SINGLE)

CHANNEL	VALUE	PERCENTAGE	FUNCTION
1	0 - 255	0 - 100	Intensity Red (0% --> 100%)
2	0 - 255	0 - 100	Intensity Green (0% --> 100%)
3	0 - 255	0 - 100	Intensity Blue (0% --> 100%)
4			Strobe
	0 - 3	0 - 1.2	Off
	4	1.6	Random Fast
	5	2.0	Random Medium
	6	2.4	Random Slow
	7 - 255	2.7 - 100	Variable Strobe (0.4Hz --> 25Hz)

9: RGBWS (PIXEL = 1; STROBE = SINGLE)

CHANNEL	VALUE	PERCENTAGE	FUNCTION
1	0 - 255	0 - 100	Intensity Red (0% --> 100%)
2	0 - 255	0 - 100	Intensity Green (0% --> 100%)
3	0 - 255	0 - 100	Intensity Blue (0% --> 100%)
4	0 - 255	0 - 100	Intensity White (0% --> 100%)
5			Strobe
	0 - 3	0 - 1.2	Off
	4	1.6	Random Fast
	5	2.0	Random Medium
	6	2.4	Random Slow
	7 - 255	2.7 - 100	Variable Strobe (0.4Hz --> 25Hz)

10: RGBAWS (PIXEL = 1; STROBE = SINGLE)

CHANNEL	VALUE	PERCENTAGE	FUNCTION
1	0 - 255	0 - 100	Intensity Red (0% --> 100%)
2	0 - 255	0 - 100	Intensity Green (0% --> 100%)
3	0 - 255	0 - 100	Intensity Blue (0% --> 100%)
4			No Effect
5	0 - 255	0 - 100	Intensity White (0% --> 100%)
6			Strobe
	0 - 3	0 - 1.2	Off
	4	1.6	Random Fast
	5	2.0	Random Medium
	6	2.4	Random Slow
	7 - 255	2.7 - 100	Variable Strobe (0.4Hz --> 25Hz)

11: DIM RGBS (PIXEL = 1; STROBE = SINGLE)

CHANNEL	VALUE	PERCENTAGE	FUNCTION
1	0 - 255	0 - 100	Dimmer (closed --> open)
2	0 - 255	0 - 100	Intensity Red (0% --> 100%)
3	0 - 255	0 - 100	Intensity Green (0% --> 100%)
4	0 - 255	0 - 100	Intensity Blue (0% --> 100%)
5			Strobe
	0 - 3	0 - 1.2	Off
	4	1.6	Random Fast
	5	2.0	Random Medium
	6	2.4	Random Slow
	7 - 255	2.7 - 100	Variable Strobe (0.4Hz --> 25Hz)

12: DIM RGBWS (PIXEL = 1; STROBE = SINGLE)

CHANNEL	VALUE	PERCENTAGE	FUNCTION
1	0 - 255	0 - 100	Dimmer (closed --> open)
2	0 - 255	0 - 100	Intensity Red (0% --> 100%)
3	0 - 255	0 - 100	Intensity Green (0% --> 100%)
4	0 - 255	0 - 100	Intensity Blue (0% --> 100%)
5	0 - 255	0 - 100	Intensity White (0% --> 100%)
6			Strobe
	0 - 3	0 - 1.2	Off
	4	1.6	Random Fast
	5	2.0	Random Medium
	6	2.4	Random Slow
	7 - 255	2.7 - 100	Variable Strobe (0.4Hz --> 25Hz)

13: DIM RGBAWS (PIXEL = 1; STROBE = SINGLE)

CHANNEL	VALUE	PERCENTAGE	FUNCTION
1	0 - 255	0 - 100	Dimmer (closed --> open)
2	0 - 255	0 - 100	Intensity Red (0% --> 100%)
3	0 - 255	0 - 100	Intensity Green (0% --> 100%)
4	0 - 255	0 - 100	Intensity Blue (0% --> 100%)
5			No Effect
6	0 - 255	0 - 100	Intensity White (0% --> 100%)
7			Strobe
	0 - 3	0 - 1.2	Off
	4	1.6	Random Fast
	5	2.0	Random Medium
	6	2.4	Random Slow
	7 - 255	2.7 - 100	Variable Strobe (0.4Hz --> 25Hz)

14: RGB CCT DIM IND S (PIXEL = 1; STROBE = SINGLE)

CHANNEL	VALUE	PERCENTAGE	FUNCTION
1	0 - 255	0 - 100	Intensity Red (0% --> 100%)
2	0 - 255	0 - 100	Intensity Green (0% --> 100%)
3	0 - 255	0 - 100	Intensity Blue (0% --> 100%)
4	0 - 4 4 - 255	0 - 1.5 1.6 - 100	Color Temperature (CCT) No effect Display color temperature Formula: $CCT = 2000 + 20 * DMX-Value$ Example: 50 --> 3000K 100 --> 4000K 150 --> 5000K <i>*CCT overwrites the RGB setting</i>
5	0..255	0 - 100	Dimmer (closed --> open)
6	0..1 2..255	0 - 0.4 0.8 - 100	LEE Color Gel No effect Display LEE color gel (full list on page 41) <i>*LEE Color Gel overwrites both, RGB and CCT</i>
7	0 - 3 4 5 6 7 - 255	0 - 1.2 1.6 2.0 2.4 2.7 - 100	Strobe Off Random Fast Random Medium Random Slow Variable Strobe (0.4Hz --> 25Hz)

15: EFFECT MODE FIX

There are two effect modes available. They offer a comprehensive control of the built in standalone engine. Settings that can otherwise only be changed on the LCD menu or by the AsteraApp™ can be directly adjusted by DMX. The two effect modes only differ in the way the color palette of four colors is set: either by RGB or by a single channel, like a color wheel. In that case, LEE Color Gels can be selected directly. Strobe is always enabled for the effect modes.

CHANNEL	VALUE	PERCENTAGE	FUNCTION
1	0..255	0 - 100	Dimmer of Pixel 1 (closed --> open)
2	0 - 3 4 5 6 7 - 255	0 - 1.2 1.6 2.0 2.4 2.7 - 100	Strobe Off Random Fast Random Medium Random Slow Variable Strobe (0.4Hz --> 25Hz)
3	0 - 7 8 - 15 16 - 23 24 - 31 32 - 39 40 - 47 48 - 55 56 - 63 64 - 71 72 - 79 80 - 87 88 - 95 96 - 101 102 - 109 110 - 117 118 - 125 126 - 133 134 - 141 142 - 149 150 - 157	0 - 2.7 3.1 - 5.9 6.3 - 9.0 9.4 - 12.2 12.5 - 15.3 15.7 - 18.4 18.8 - 21.6 22.0 - 24.7 25.1 - 27.8 28.2 - 31.0 31.4 - 34.1 34.5 - 37.3 37.6 - 39.6 40.0 - 42.7 43.1 - 45.9 46.3 - 49.0 49.4 - 52.2 52.5 - 55.3 55.7 - 58.4 58.8 - 61.6	Program One Color Static Two Color Static Three Color Static Four Color Static One Color Fade Two Color Fade Three Color Fade Four Color Fade Simple Running Double Running Two Col Running Flag Running Double Flag Running Spiral 4 Color Spiral 2 Color Rainbow Fire Rotor Rotor Split 2 Rotor Split 4
4	0..255	0 - 100	Speed (slow --> fast)
5	0..255	0 - 100	Crossfade (no fade --> smooth fade)
6	0 - 63 64 - 127 128 - 190 191 - 255	0 - 24.7 25.1 - 49.8 50.2 - 74.5 74.9 - 100	Direction Forward with Loop Forward one time and stop Reverse one time and stop Reverse with Loop
7			Size <i>Defines the virtual size of the program in groups E.g. if SIZE is set to 2 groups only half of the program is shown on the unit.</i>



	0 - 63 64 - 127 128 - 190 191 - 255	0 - 24.7 25.1 - 49.8 50.2 - 74.5 74.9 - 100	1 Group 2 Groups 3 Groups 4 Groups
8	0..255	0 - 100	Offset <i>If SIZE is set to >1 group, the units pixels can be shifted within the virtually larger program. Increasing the OFFSET parameter scrolls the position of the unit within the virtual large program.</i>
9	0..255	0 - 100	Restart Program <i>If value is changed, the program starts again from the beginning (useful if DIRECTION is not set to loop).</i>
10	0..1 2..255	0 - 0.4 0.8 - 100	LEE Color Gel 1 No effect Display LEE color gel (full list on page 41)
11	0..1 2..255	0 - 0.4 0.8 - 100	LEE Color Gel 2 No effect Display LEE color gel (full list on page 41)
12	0..1 2..255	0 - 0.4 0.8 - 100	LEE Color Gel 3 No effect Display LEE color gel (full list on page 41)
13	0..1 2..255	0 - 0.4 0.8 - 100	LEE Color Gel 4 No effect Display LEE color gel (full list on page 41)

16: EFFECT MODE RGB

CHANNEL	VALUE	PERCENTAGE	FUNCTION
1	0..255	0 - 100	Dimmer of Pixel 1 (closed --> open)
2	0 - 3 4 5 6 7 - 255	0 - 1.2 1.6 2.0 2.4 2.7 - 100	Strobe Off Random Fast Random Medium Random Slow Variable Strobe (0.4Hz --> 25Hz)
3	0 - 7 8 - 15 16 - 23 24 - 31 32 - 39 40 - 47 48 - 55 56 - 63 64 - 71 72 - 79 80 - 87 88 - 95 96 - 101 102 - 109 110 - 117 118 - 125 126 - 133 134 - 141 142 - 149 150 - 157	0 - 2.7 3.1 - 5.9 6.3 - 9.0 9.4 - 12.2 12.5 - 15.3 15.7 - 18.4 18.8 - 21.6 22.0 - 24.7 25.1 - 27.8 28.2 - 31.0 31.4 - 34.1 34.5 - 37.3 37.6 - 39.6 40.0 - 42.7 43.1 - 45.9 46.3 - 49.0 49.4 - 52.2 52.5 - 55.3 55.7 - 58.4 58.8 - 61.6	Program One Color Static Two Color Static Three Color Static Four Color Static One Color Fade Two Color Fade Three Color Fade Four Color Fade Simple Running Double Running Two Col Running Flag Running Double Flag Running Spiral 4 Color Spiral 2 Color Rainbow Fire Rotor Rotor Split 2 Rotor Split 4
4	0..255	0 - 100	Speed (slow --> fast)
5	0..255	0 - 100	Crossfade (no fade --> smooth fade)
6	0 - 63 64 - 127 128 - 190 191 - 255	0 - 24.7 25.1 - 49.8 50.2 - 74.5 74.9 - 100	Direction Forward with Loop Forward one time and stop Reverse one time and stop Reverse with Loop
7	0 - 63 64 - 127 128 - 190	0 - 24.7 25.1 - 49.8 50.2 - 74.5	Size <i>Defines the virtual size of the program in groups</i> <i>E.g. if SIZE is set to 2 groups only half of the program is shown on the unit.</i> 1 Group 2 Groups 3 Groups



	191 - 255	74.9 - 100	4 Groups
8	0..255	0 - 100	Offset <i>If SIZE is set to >1 group, the unit's pixels can be shifted within the virtually larger program. Increasing the OFFSET parameter scrolls the position of the unit within the virtual large program.</i>
9	0..255	0 - 100	Restart Program <i>If value is changed, the program starts again from the beginning (useful if DIRECTION is not set to loop).</i>
10	0 - 255	0 - 100	Intensity Red of Color 1 (0% --> 100%)
11	0 - 255	0 - 100	Intensity Green of Color 1 (0% --> 100%)
12	0 - 255	0 - 100	Intensity Blue of Color 1 (0% --> 100%)
13	0 - 255	0 - 100	Intensity Red of Color 1 (0% --> 100%)
14	0 - 255	0 - 100	Intensity Green of Color 1 (0% --> 100%)
15	0 - 255	0 - 100	Intensity Blue of Color 1 (0% --> 100%)
16	0 - 255	0 - 100	Intensity Red of Color 1 (0% --> 100%)
17	0 - 255	0 - 100	Intensity Green of Color 1 (0% --> 100%)
18	0 - 255	0 - 100	Intensity Blue of Color 1 (0% --> 100%)
19	0 - 255	0 - 100	Intensity Red of Color 1 (0% --> 100%)
20	0 - 255	0 - 100	Intensity Green of Color 1 (0% --> 100%)
21	0 - 255	0 - 100	Intensity Blue of Color 1 (0% --> 100%)



LEE COLOR GELS

CHANNEL	VALUE	PERCENTAGE	FUNCTION
	0..1	0 - 0.4	No effect
	2	0.8	Rose Pink
	3	1.2	Lavender Tint
	4	1.6	Medium Bastard Amber
	7	2.7	Pale Yellow
	8	3.1	Dark Salmon
	9	3.5	Pale Amber Gold
	10	3.9	Medium Yellow
	13	5.1	Straw Tint
	15	5.9	Deep Straw
	17	6.7	Surprise Peach
	19	7.5	Fire
	20	7.8	Medium Amber
	21	8.2	Gold Amber
	22	8.6	Dark Amber
	24	9.4	Scarlet
	25	9.8	Sunset Red
	26	10.2	Bright Red
	27	10.6	Medium Red
	29	11.4	Plasa Red
	35	13.7	Light Pink
	36	14.1	Medium Pink
	46	18.0	Dark Magenta
	48	18.8	Rose Purple
	49	19.2	Medium Purple
	52	20.4	Light Lavender
	53	20.8	Paler Lavender
	58	22.7	Lavender
	61	23.9	Mist Blue
	63	24.7	Pale Blue
	68	26.7	Sky Blue
	71	27.8	Tokyo Blue
	75	29.4	Evening Blue
	79	31.0	Just Blue
	85	33.3	Deeper Blue
	88	34.5	Lime Green
	89	34.9	Moss Green
	90	35.3	Dark Yellow Green
	100	39.2	Spring Yellow
	101	39.6	Yellow
	102	40.0	Light Amber



	103	40.4	Straw
	104	40.8	Deep Amber
	105	41.2	Orange
	106	41.6	Primary Red
	107	42.0	Light Rose
	108	42.4	English Rose
	109	42.7	Light Salmon
	110	43.1	Middle Rose
	111	43.5	Dark Pink
	113	44.3	Magenta
	115	45.1	Peacock Blue
	116	45.5	Medium Blue-Green
	117	45.9	Steel Blue
	118	46.3	Light Blue
	119	46.7	Dark Blue
	120	47.1	Deep Blue
	121	47.5	LEE Green
	122	47.8	Fern Green
	124	48.6	Dark Green
	126	49.4	Mauve
	127	49.8	Smokey Pink
	128	50.2	Bright Pink
	129	50.6	Heavy Frost
	130	51.0	Clear
	131	51.4	Marine Blue
	132	51.8	Medium Blue
	134	52.5	Golden Amber
	135	52.9	Deep Golden Amber
	136	53.3	Pale Lavender
	137	53.7	Special Lavender
	138	54.1	Pale Green
	139	54.5	Primary Green
	140	54.9	Summer Blue
	141	55.3	Bright Blue
	142	55.7	Pale Violet
	143	56.1	Pale Navy Blue
	144	56.5	No Colour Blue
	147	57.6	Apricot
	148	58.0	Bright Rose
	151	59.2	Gold Tint
	152	59.6	Pale Gold
	153	60.0	Pale Salmon
	154	60.4	Pale Rose
	156	61.2	Chocolate



	157	61.6	Pink
	158	62.0	Deep Orange
	159	62.4	No Colour Straw
	161	63.1	Slate Blue
	162	63.5	Bastard Amber
	164	64.3	Flame Red
	165	64.7	Daylight Blue
	169	66.3	Lilac Tint
	170	66.7	Deep Lavender
	172	67.5	Lagoon Blue
	174	68.2	Dark Steel Blue
	176	69.0	Loving Amber
	179	70.2	Chrome Orange
	180	70.6	Dark Lavender
	181	71.0	Congo Blue
	182	71.4	Light Red
	183	71.8	Moonlight Blue
	184	72.2	Cosmetic Peach
	186	72.9	Cosmetic Silver Rose
	187	73.3	Cosmetic Rouge
	188	73.7	Cosmetic Highlight
	189	74.1	Cosmetic Silver Moss
	191	74.9	Cosmetic Aqua Blue
	192	75.3	Flesh Pink
	194	76.1	Surprise Pink
	195	76.5	Zenith Blue
	196	76.9	True Blue
	197	77.3	Alice Blue
	198	77.6	Palace Blue
	199	78.0	Regal Blue
	200	78.4	Double CT Blue
	201	78.8	Full CT Blue
	202	79.2	1/2 CT Blue
	203	79.6	1/4 CT Blue
	204	80.0	Full CT Orange
	205	80.4	1/2 CT Orange
	206	80.8	1/4 CT Orange
	207	81.2	Full CT Orange +
	208	81.6	Full CT Orange +
	209	82.0	0.3 Neutral Density
	210	82.4	0.6 Neutral Density
	211	82.7	0.9 Neutral Density
	212	83.1	LCT Yellow
	213	83.5	White Flame Green



	216	84.7	White Diffusion
	217	85.1	Blue Diffusion
	218	85.5	1/8 CT Blue
	219	85.9	LEE Fluorescent Green
	220	86.3	White Frost
	221	86.7	Blue Frost
	223	87.5	1/8 CT Orange
	224	87.8	Daylight Blue Frost
	225	88.2	LEE N.D. Frost
	226	88.6	LEE U.V.
	228	89.4	Brushed Silk
	229	89.8	1/4 Tough Spun
	230	90.2	Super Correction
	232	91.0	Super White Flame Green
	236	92.5	H.M.I (To Tungsten)
	237	92.9	C.I.D. (To Tungsten)
	238	93.3	C.S.I. (To Tungsten)
	239	93.7	Polariser
	241	94.5	LEE Fluorescent 5700 K
	242	94.9	LEE Fluorescent 4300 K
	243	95.3	LEE Fluorescent 3600 K
	244	95.7	LEE Plus Green
	245	96.1	1/2 Plus Green
	246	96.5	1/4 Plus Green
	247	96.9	LEE Minus Green
	248	97.3	1/2 Minus Green
	249	97.6	1/4 Minus Green
	250	98.0	1/2 White Diffusion
	251	98.4	1/4 White Diffusion
	252	98.8	1/8 White Diffusion
	253	99.2	Hampshire Frost
	254	99.6	New Hampshire Frost
	255	100.0	Hollywood Frost



10 VERSION HISTORY

29.06.2015	Initial version
27.06.2017	Dimmer Curves added
16.07.2018	Translation paragraph removed, the word "PIN" capitalized, DMX Table changed to Profile, Input Select updated with new options, Numeric DMX profile added, Lee Color Gel Index added