

CITY THEATRICAL

NEW YORK • LONDON

QolorStrip™ Battery powered LED Strip

User's Manual



© 2015 City Theatrical, Inc.

QolorStrip battery powered LED uplighter is covered by U.S. Patent # 7,432,803 and other patents pending.

US HEADQUARTERS
475 BARELL AVENUE
CARLSTADT, NEW JERSEY 07072
TEL 800 230 9497 / 201 549 1160
FAX 201 549 1161

www.citytheatrical.com

LONDON OFFICE
UNIT 1-3 WYVERN ESTATE, BEVERLEY WAY
NEW MALDEN, SURREY KT3 4PH
TEL +44 (0) 20 8949 5051
FAX +44 (0) 20 7183 6061

Contents

Disclaimer 2

Product Modification..... 3

Radio Compliance Information 3

 5792M SHoW DMX Neo Radio CE Declaration of Conformity 4

System Compliance Information 6

Safety Notices 6

Introduction 7

 QolorPoint Wireless Uplighter features 7

 Product Contents 8

Charging..... 8

User Interface..... 9

 Power..... 9

 External Power (Optional Accessory)..... 9

Function Modes..... 10

 Cust Col Mode Operation 10

 Static Mode Operation 11

 DMX Mode Operation 12

 Built-In Effects..... 13

SHoW DMX SHoW ID Settings..... 14

 SHoW DMX ID LED..... 14

Lamp Profile..... 15

 Power Mode..... 15

 Brightness Control 15

 PWM Frequency Control 15

 Keypad Lock 16

Mechanical 18

 Dimensions 19

 Antenna..... 20

Appendix 1- DMX Mapping Table 21

Warranty 22

Disclaimer

City Theatrical Inc. believes the information in this manual is accurate and complete however assumes no responsibility for any error or omissions within this document or any other documentation accompanying the product. We reserve the right to revise this document at any time. Please see <http://www.citytheatrical.com> to download latest version.

Product Modification

This City Theatrical product has been designed and manufactured to meet the strict requirements of U.S., EU and International safety regulations. Any unauthorized modifications to the product including replacement of parts with non-standard parts could compromise safety and result in the product being non-compliant with relevant standards.

There are no user serviceable parts within this product.

Radio Compliance Information

5792M SHoW DMX Neo® Radio Module

FCC ID: VU65792M

IC: 7480A-5792M

FCC Part 15

This equipment has been tested and found to comply with the limits for a Class B digital device, pursuant to part 15 of the FCC Rules. These limits are designed to provide reasonable protection against harmful interference in a residential installation. This equipment generates, uses, and can radiate radio frequency energy and, if not installed and used in accordance with the instructions, may cause harmful interference to radio communications. However, there is no guarantee that interference will not occur in a particular installation.

If this equipment does cause harmful interference to radio or television reception, which can be determined by turning the equipment off and on, the user is encouraged to try to correct the interference by one or more of the following measures:

- Reorient or relocate the receiving antenna.
- Increase the separation between the equipment and receiver.
- Connect the equipment into an outlet on a circuit different from that to which the receiver is connected.
- Consult the dealer or an experienced radio/ TV technician for help.

Radio Frequency Notifications

FCC Notifications

RF Radiation

The Product is an intentional radiator of Radio Frequency (RF) energy. In order to limit RF exposure to personnel in the immediate area, the Product should be located and installed such that a separation of at least 8" (20 cm) is maintained between the Product's antenna and personnel in the vicinity of the device.

Modification Warning

Caution: changes or modifications to this equipment, not expressly approved by City Theatrical Inc. could void the user's authority to operate the equipment.

Industry Canada Notifications

This Class B digital apparatus complies with Canadian ICES-003. Operation is subject to the following two conditions: (1) this device may not cause interference, and (2) this device must accept any interference, including interference that may cause undesired operation of the device.

Cet appareil numérique de la classe B est conforme à la norme NMB-003 du Canada.

Product Installation and Configuration Guide © City Theatrical Inc. 2007

CE Mark Conformity

City Theatrical Inc. declares that this product conforms to the specifications listed in this manual, following the provisions of the European R&TTE directive 1999/5/EC:

City Theatrical Inc. vakuuttaa täten että dieses produkt tyypinen laite on direktiivin 1999/5/EY oleellisten vaatimusten ja sitä koskevien näiden direktiivien muiden ehtojen mukainen.

City Theatrical Inc. déclare que le produit est conforme aux conditions essentielles et aux dispositions relatives à la directive 1999/5/EC.

- EN 301 489-1, 301 489-17 General EMC requirements for Radio equipment.
- EN 60950 Safety
- EN 300 328 Technical requirements for Radio equipment.

CAUTION—this equipment is intended to be used in all EU and EFTA countries.

Outdoor use may be restricted to certain frequencies and/or may require a license for operation. Contact local Authority for procedure to follow.

Avoid using this product during an electrical storm. There may be a remote risk of electric shock from lightning.

Product Installation and Configuration Guide © City Theatrical, Inc. 2015

Q52 Regulatory information

Radio Frequency Notifications

Belgique Dans le cas d'une utilisation privée, à l'extérieur d'un bâtiment, au-dessus d'un espace public, aucun enregistrement n'est nécessaire pour une distance de moins de 300m. Pour une distance supérieure à 300m un enregistrement auprès de l'IBPT est requise. Pour une utilisation publique à l'extérieur de bâtiments, une licence de l'IBPT est requise. Pour les enregistrements et licences, veuillez contacter l'IBPT.

France 2.4 GHz Bande : les canaux 10, 11, 12, 13 (2457, 2462, 2467, et 2472 MHz respectivement) sont complètement libres d'utilisation en France (en utilisation intérieur). Pour ce qui est des autres canaux, ils peuvent être soumis à autorisation selon le département. L'utilisation en extérieur est soumis à autorisation préalable et très restreint. Vous pouvez contacter l'Autorité de Régulation des Télécommunications (<http://www.art-telecom.fr>) pour de plus amples renseignements.

CITY THEATRICAL

NEW YORK • LONDON



EC Certificate of Conformity

Products covered by this Certificate

SHoW DMX Neo®

5792M Radio Module

This equipment complies with the requirements of the R&TTE Directive 1999/5/EC

Standards Applied:

ETSI EN 300 328 V1.8.1 (2012-06)

We have carried out all of the essential radio test suites according to the Standard EN 300 328 V1.8.1 harmonized under Article 3.2 of the R&TTE Council Directive 1999/5/EC. We have found that the model: 5792M complies with the requirements of the above-mentioned Standard.

EN 301-489-1 V1.9.2 (2011-09)

EN 301 489-17 V2.2.1 (2012-09)

We have carried out all of the required tests according to the Standards: ETSI EN 301 489-1 V1.9.2 and ETSI EN 301 489-17 V2.2.1 harmonized under Article 3.1(b) of the R&TTE Council Directive 1999/5/EC and Articles 4(a), 4(b) of the EMC Directive 2004/108/EC. We have found that the model 5792M complies with the requirements of the above-mentioned Standards.

Date of Issue: January 1, 2015

Year CE Marking First Affixed: 2015

Paul Kleissler, Head of Engineering

US HEADQUARTERS
475 BARELL AVENUE
CARLSTADT, NEW JERSEY 07072
TEL 800 230 9497 / 201 549 1160
FAX 201 549 1161

www.citytheatrical.com

LONDON OFFICE
UNIT 1-3 WYVERN ESTATE, BEVERLEY WAY
NEW MALDEN, SURREY KT3 4PH
TEL +44 (0) 20 8949 5051
FAX +44 (0) 20 7183 6061

System Compliance Information



The QolorStrip Wireless LED Batten

City Theatrical Incorporated declares that this product conforms to the specifications listed in this manual, following the provisions of the European R&TTE directive 1999/5/EC:

Restrictions on Hazardous Substances (RoHS) (2002/95/CE)
Electromagnetic Compatibility (2004/108/EC).
Safety (EN 60950)
Technical requirements for radio equipment. (EN 300 328)

CAUTION—This equipment is intended to be used in all EU and EFTA countries. Outdoor use may be restricted to certain frequencies and/or may require a license for operation. Contact local Authority for procedure to follow.

WEEE & RoHS Statement



The European Directive 2002/96/EC on Waste Electrical and Electronic Equipment (WEEE), requires that products must not be disposed of the normal unsorted municipal waste stream. Appliances must be collected separately in order to optimize the recovery and recycling of the materials they contain and reduce the impact on human health and the environment.

The consumer must contact their local authority or retailer for information concerning disposal of their products.

City Theatrical provides a take-back facility for batteries used within City Theatrical products, although the expense for transport remains the liability of the consumer. Please contact City Theatrical directly if this service is required.

Safety Notices

Please read this entire manual before using your new equipment. Please keep the manual in a safe place so you can refer to it in the future as required.

The QolorPoint battery powered LED uplighter is intended for use only by qualified professionals. Connection, installation and hanging of this equipment must be performed in accordance with all pertinent local, regional and national safety codes and regulations.

Be sure installation provides adequate ventilation. Some system components can produce significant heat and must be properly installed to allow proper cooling and assure user safety. All sides of the equipment must be clear of obstruction and allow free airflow.

There are no user-serviceable parts inside! Refer to qualified service personnel!

Safety

- AVOID direct eye exposure to the light source when illuminated
- DO NOT submerge this product in water
- DO NOT hang this product other than by the means indicated in this manual
- DO NOT leave any flammable material near product while operating or charging
- ALWAYS use the supplied charger or charging case
- ALWAYS ensure the charger is connected to the specified voltage
- ALWAYS ensure the charging case lid is open whilst plugged into mains supply
- NEVER connect this product or charger to a dimmer pack
- DO NOT operate this fixture if it appears damaged in any way
- DO NOT operate this fixture where the ambient temperature exceeds 115°F (45°C)

In the unlikely event that your product develops a fault, please contact your local dealer or authorized distributor. Do not attempt to repair yourself unless specifically instructed by City Theatrical Inc.

Note: Restrictions apply to transporting this equipment on aircraft due to the lithium polymer batteries having capacity greater than 100Wh. Please consult IATA Packing Instructions 967 and City Theatrical Inc. for further information.

Introduction

The QolorStrip is a battery-powered wireless LED strip capable of providing portable and instant architectural and feature lighting anywhere. With high-powered red, green, blue and white LEDs the fixture is capable of producing any color or shade of white using combinations of those LEDs. Ideal for illuminating buildings in color, both indoors and outdoors, the fixture is powerful enough to light buildings of 3 or 4 stories. Lighting effects may be created by connecting to effects generators such as lighting desks or other CORE Master units using the in-built City Theatrical Show DMX Neo Max Wireless DMX receiver. Simply connect wirelessly to the transmitter of the generator.

QolorStrip Battery Powered Wireless LED Strip features

- High powered 4,000 lumen RGBW LEDs equivalent to 9700 Lux @ 2m
- 18 x Cree high-powered RGBW LED arrays
- Lithium Ion battery reducing unit weight to just 6.5kg with battery life of up to 8 hours
- Mains input allowing unit to run in a permanent installation plus mains out to other units
- LEE Filter Color library or separate RGBW control.
- City Theatrical Show DMX Neo Max wireless DMX as Master or Slave control
- 4 or 5 or 8 or 72 Channel DMX operation and variable PWM frequency for TV work
- Cable DMX input plus DMX Output to other fixtures (incl ShowDMX to DMX conversion)
- Mounting options to allow unit to be floor mounted or fixed to truss or other mounting.
- IP65 outdoor rated case
- Operating temperature range -0 to +35 degree C or 32 to +95 degree F

Product Contents

Please contact your dealer immediately if there are any signs of product damage or parts missing.

Single unit

- 1x QolorStrip wireless LED fixture
- 1x Power cable
- 1x Quick Start Guide

Charging case of four units

- 4x QolorStrip Wireless LED fixtures
- 1x Charging case
- 1x Powercon Cable
- 1x Manual

Getting Started

QolorStrip key Elements

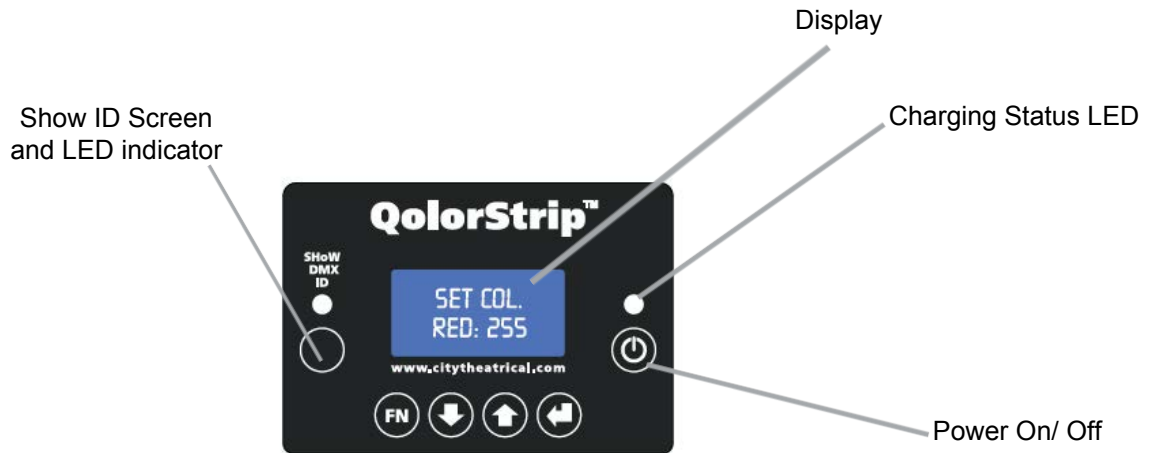

Operation

Turning On and Off



- Push and hold this power button for >1 second to switch the unit ON or OFF
- The display will show “City Theatrical” and software version for a few seconds before starting
- The display backlight will extinguish after a short time to reduce power use

Battery Charging

- The fixture has a built-in charger optimized for the battery and will charge while attached to the mains supply whether the unit is active or not
- Only use the supplied mains cable or charging case
- For best results recharge battery fully before storage
- When charging in the charging case, it is best to ensure the case lid remains open to disperse heat, although the lid may be closed in cooler climates.
- Switch off the charger unit and unplug once fully charged
- While charging the LED indicator will illuminate in RED or AMBER
- (Red indicates an empty battery moving to Amber when significantly charged)
- Once fully charged the LED indicator will show GREEN

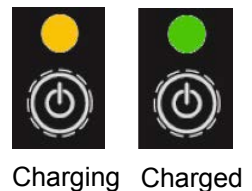

DO NOT use any charger other than the unit supplied with the QolorStrip



When using a charging flight case, ensure the unit is pushed fully down on the charging connector. The charge light on side of the unit should illuminate to signify this has been done.

Mains Power

- The fixture can be run from mains power attached to the “PowerCON” connector (PowerCON True1) on the side
- While running from mains the mains symbol is shown in the top right hand corner of the display.
- It will recharge the battery when mains is applied to the Powercon input connector but note that the rate of charging is reduced if the fixture is on
- A Powercon mains output connector on the left side of the fixture allows mains to be daisy-chained from one fixture to another.



Note that no more than 4 units can be daisy chained

Control Panels



Enables changes to FUNCTION or SETTINGS menus
Exits from the current option or menu



Navigates backward through the menu list
or increments a numeric value
or navigates forward through available values



Navigates forward through the menu list
or increments a numeric value
or navigates forward through available values







Enters the currently displayed menu option
or saves the currently displayed value

Function Modes

There are four modes of Operation, accessed through the **FUNCTION** menu;

Custom Color	This mode allows the fixture to output a static Red, Green, Blue or White color, or any combination thereof; each color may be set to any value 0 to 255. Any SHoW DMX signal, if present, is ignored.
Static	In this mode the fixture outputs a static LEE or preset 'cc' color as selected. The selection is remembered if the unit is switched off then back on or put into another mode. Any SHoW DMX signal, if present, is ignored.
DMX	In this mode the fixture is under control of SHoW DMX so may be controlled by a SHoW DMX compatible device or DMX compatible device with a SHoW DMX transmitter attached. The options available within DMX mode are described in more detail below.
Effects	In this mode the fixture generates a number of special effects. The speed of effect types can be adjusted from 1 to 10.

To change Function press . Use the  buttons to select "CHANGE Function" and press  to accept. Then use the  buttons to select the required function as above and press . The four modes of operation are discussed in more detail below.

All of these adjust the brightness settings for each color.

Custom Color Mode Operation

Custom Colors

When in Custom Color mode, the display indicates the current selected color

Simply press  to step through the colors or accept a color value.

Use  keys to change the value.

Value range 0 to 255.

Tip: Mix red & blue for purple/pink

Tip: Mix red & green for orange/yellow



Tip: Mix red & green with White for warm shades of white.



Static Mode Operation

Static operation

When in STATIC mode the display indicates the current selected color.

To change the current selected color press .

The last character of the currently selected color is underlined.

Use the   keys to select a color from the built-in library of 70 pre-programmed colors, including 60 popular LEE Filter Colors

The color changes when cycling through the available options. The selected color is only saved when <ENTER> is pressed. If <ENTER> is not pressed, the color reverts to the previously selected color after 8 seconds.

Available colors

cc001	White	Lee075	Evening Blue	Lee157	Pink
cc002	Half Flesh Tone	Lee089	Moss Green	Lee159	No Color Straw
cc003	Full Flesh Tone	Lee100	Spring Yellow	Lee162	Bastard Amber
cc004	Half Mint Green	Lee101	Yellow	Lee170	Deep Lavender
cc005	Mint Green	Lee102	Light Amber	Lee174	Dark Steel Blue
cc006	Half Ice Blue	Lee103	Straw	Lee181	Congo Blue
cc007	Full Ice Blue	Lee104	Deep Amber	Lee192	Flesh Pink
cc008	Soft Red	Lee106	Primary Red	Lee199	Regal Blue
cc009	Soft Green	Lee107	Light Rose	Lee323	Jade
cc010	Soft Blue	Lee108	English Rose	Lee341	Plum
		Lee113	Magenta	Lee345	Fuchsia
Lee002	Rose Pink	Lee115	Peacock Blue	Lee353	Lighter Blue
Lee009	Pale Amber Gold	Lee117	Steel Blue	Lee652	Urban Sodium
Lee010	Medium Yellow	Lee118	Light Blue	Lee722	Bray Blue
Lee013	Straw Tint	Lee119	Dark Blue	Lee724	Ocean Blue
Lee015	Deep Straw	Lee121	Lee Green	Lee738	Jazz Green
Lee017	Surprise Peach	Lee126	Mauve	Lee765	Lee Yellow
Lee019	Fire	Lee127	Smoky Pink	Lee776	Nectarine
Lee020	Medium Amber	Lee135	Deep Amber Gold	Lee777	Rust

Lee024	Scarlet	Lee136	Pale Lavender	Lee779	Bastard Pink
Lee026	Bright Red	Lee138	Pale Green	Lee789	Blood Red
Lee046	Dark Magenta	Lee139	Primary Green	Lee793	Vanity Fair
Lee058	Lavender	Lee147	Apricot	Lee795	Magical Magenta
Lee068	Sky Blue	Lee153	Pale Salmon		

DMX Mode Operation



DMX Operation

City Theatrical QolorPoint is equipped with a SHoW DMX Neo wireless radio transmitter and receiver. This allows the fixture color to be set up by or synchronized with sequences produced by a DMX lighting controller or other QolorPoint unit when in Receive, or SLAVE mode.



Alternatively when in MASTER mode the unit can be linked to many Slave units which will then duplicate everything output from the Master.

If not using a QolorPoint as a Master unit then a compatible SHoW DMX transmitter attached to a DMX controller is necessary, available separately.

When the 'Function DMX' screen is shown, after a few seconds the screen automatically reverts to the last mode used, either Master or Slave. By pressing the  button the 'DMX Type' screen is shown, which allows the user to select the opposite mode using  button.



DMX Master Operation

Once Master mode is set, the Master may transmit to any number of slaves by selecting a matching SHoW ID using the SHoW DMX ID button.



DMX Slave Operation





When in DMX Slave mode the display will show the current active DMX Start Address so the unit can be controlled from elsewhere.



The number of channels occupied is dependent on the **"DMX MODE"** setting (4 or 5 channels may be used by the fixture).

In this mode the entire universe is output on a side connector pin, for which a connector cable is available from City Theatrical Inc. for connection to other non-wireless fixtures.



DMX Start Address

To set the DMX start address press  button when the display shows the current address. Use the   buttons to select the new start address then  to confirm.

Built-In Effects

The QolorPoint is now equipped to generate a number of special effects as a stand-alone unit when DMX is placed in Slave Mode or will output these to a number of connected slave units when DMX is in Master Mode.

By pressing the  button the last used effect type is brought up, which

can then be changed using the   buttons.

By pressing the  button to confirm the effect type, the speed can be

adjusted from a range 1 to 10 using the   buttons.

When confirmed with the  button the screen reverts to show the effect

and speed.



FUNCTION
EFFECT



TYPE:
R'BOW 1



EFFECT
R'BOW 10



SPEED:
01

SHoW DMX SHoW ID Settings

The QolorPoint uplighter uses the 5792M SHoW DMX Neo with Max Technology Radio Module. It is permanently configured with six SHoW ID options for Adaptive Spread Spectrum Frequency Hopping and Neo Low Latency broadcast mode. The SHoW ID can be changed by pressing the SHoW DMX ID button on the control panel of the QolorPoint uplighter.

Color	SHoW ID	Description
Green	201	Neo Adaptive
Cyan	102	Neo Full Bandwidth
Magenta	117	Neo Low Limited Bandwidth
White	133	Neo Mid Limited Bandwidth
Red	149	Neo High Limited Bandwidth
Yellow	165	MAX Technology™

For QolorPoint Slave units to communicate with Master QolorPoint units or a lighting control desk, equipped with a SHoW DMX transmitter connected to its DMX output, the SHoW ID LED color has to be the same.

This allows a group of QolorPoint fixtures to be controlled from the lighting desk or Master unit using the built-in color cycles or set up individually selected colors across many units at once from just one Master unit.

SHoW DMX ID LED

The SHoW DMX LED color signifies the SHoW ID it is set to and indicates presence of DMX data.

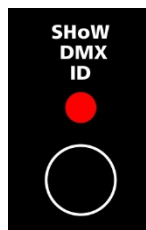

Description for operation in Slave mode:

If the LED is FLASHING, the QolorPoint is not receiving DMX from a SHoW DMX transmitter.

If the LED is STEADILY ILLUMINATED the QolorPoint is connected with, and receiving DMX from a SHoW DMX transmitter. This is a fully connected and fully functioning system.

Configuring with SHoW DMX Transmitter unit or QolorPoint Master unit

- Switch on the QolorPoint
- Set one unit to Master Mode and other units to Slave Mode
- Set the SHoW IDs on both Slave and Master to the same ID.
- Units will automatically connect when set to the same ID

For successful connection the receiver must fulfill the following conditions:

Distance to transmitter (outdoors, and depending on conditions)

- Less than 1,500ft. for SHoW Baby or SHoW DMX Neo Transceiver

Distance between Master unit and Slave unit

- Less than 300ft

Position above obstacles (e.g. crowds and trees)

- Minimum 3ft

SHoW ID configuration between Slave and Master is remembered after power off or the battery is depleted.

This allows the system configuration to be set up in a warehouse and the whole system simply switched on at the site, which makes deployment very simple.

Additional Settings

A number of additional settings may be accessed within the menu system:

Power Mode

Under the “**CHANGE Settings**” menu QolorPoint has two power modes that can be selected:

Power LongLife 50% Power



Power Normal Full Power

The “Normal” option provides maximum light output at the cost of reduced battery life.

“LongLife” reduces the LED output by 50%, therefore enables 2 x running period for ALL FUNCTIONS, whether stand-alone or DMX.

To change the power mode press  and use the  buttons to select “**CHANGE Settings**” then press .



Use the  buttons to select “**POWER MODE**” and press  to select.

Use  buttons to toggle between “Norm” and “LongLife” then press  to save changes. This setting affects all Static, Custom Color and DMX modes so that the battery life of each unit can be individually set, irrespective of what’s controlling it.



Brightness Control

Under the “**CHANGE Settings**” menu QolorPoint has a separate brightness control that can control the output of the unit in stand-alone mode:

The value may be changed from 0 to 100% in 1% increments:

Press  and use the  buttons to select “**CHANGE Settings**” then press  to accept.



Use the  buttons to select “**BRIGHTNS CONTROL**” and press  to select.

Use  buttons to toggle between “0%” and “100%” then press  to save changes. This setting adjusts Static and Custom Color modes only. DMX mode remains unchanged as the unit remains under external control.

PWM Frequency Control

For HD TV work QolorPoint is equipped with an option to adjust the PWM frequency of the LEDs to prevent ‘beating’ with the TV scan frequency.

To enable soft dimming press  and use the  buttons to select “**CHANGE Settings**” then press  to select.

Then use the  buttons to select “**PWM Freq**” and press  to select from value 244 Hz to 1.9kHz.

Press  to save changes and the screen will revert to showing the 'Function' mode.

Keypad Lock

The keypad may be locked to prevent tampering or inadvertent adjustment of the unit.



To Lock: Hold down the  while switching ON the unit to Lock.

To Unlock: First switch OFF the unit. Hold down the  while switching ON the unit to Unlock.

Mechanical

Locking

The unit may be locked to a nearby object by passing a locking wire or padlock through the locking holes in the top or bottom plates.

Use   keys to toggle between “0%” and “100%” then press  save changes. This setting adjusts Static, Cost Col and Effect modes only.

In DMX slave mode the Brightness control will have no effect if the DMX mode includes dimmer data. Ie the Brightness control will be inactive when set to 5 channel and 9 channel mode but active when 4 channel, 8 channel and 72 channel is selected.

DMX Mode



The DMX channel mapping for each LED output on the fixture can be selected. A pixel consists of 4 LEDs: Red, Green, Blue, White. Pixel 1 is the right-hand end LED cluster on the batten, pixel 18 is the left-hand end LED cluster.

DMX form	
4 channel	All 18 pixels are controlled by 4 DMX channels for Red, Green Blue, White. No dimmer channel
5 channel	All 18 pixels are controlled by 4 DMX channels for Red, Green Blue, White and the 5th channel controls the brightness (Dimmer channel)
8 channel	Pixels 1 to 8 on RHS of fixture are controlled by channels 1 to 4 Pixels 9 to 18 on LHS of fixture are controlled by channels 5 to 8. No dimmer channel
9 channel	Pixels 1 to 8 on RHS of fixture are controlled by channels 1 to 4 Pixels 9 to 18 on LHS of fixture are controlled by channels 5 to 8 Channel 9 controls the overall brightness (Dimmer channel)
72 channel	Full pixel mapping such that each led in each pixel is controlled. No dimmer channel

A full mapping table is shown in Appendix 1 of this document.





Press  and use the   keys to select “**CHANGE Settings**” then press  . to accept.

Use the   keys to select “DMX Format” and press  to select.



Use   keys to toggle between 4, 5, 8, 9 or 72 Chan mode then press  to save changes.

PWM Frequency Control

For HD TV work StripPoint is equipped with an option to adjust the PWM frequency of the LEDs to prevent ‘beating’ with the TV scan frequency.

Press  and use the   keys to select “CHANGE Settings” then press  to accept.





Use the   keys to select “PWM Freq” and press  to select.

Use   keys to toggle between 4, 5, 8, 9 or 72 Channel mode then press  to save changes.



 ***Beware that when using the higher frequencies the resolution of the color intensity steps is reduced, so the effect of color changing can become less smooth and more ‘steppy’.***

Lamp Profile

The dimming curve can be selected to optimize for different applications





Press  and use the   keys to select “CHANGE Settings” then press  to accept.

Use the   keys to select “Lamp Profile” and press  to select.

Then use the   keys to select “Sq. Law” or “Linear” curve. Press  to save changes and the screen will revert to showing the ‘Function’ mode.

W-DMX Power

The Wireless DMX can be turned off so the unit will only respond to, and transmit from, the physical DMX connectors

Press  and use the   keys to select “CHANGE Settings” then press  to accept.

Use the   keys to select “DMX Power” and press  to select.

Then use the   keys to select “On” or “Off”. Press  to save changes and the screen will revert to showing the ‘Function’ mode.



Keypad Lock

The keypad may be locked to prevent tampering or inadvertent adjustment of the unit.

To Lock: Hold down the  whilst switching ON the unit to Lock.

To Unlock: First switch OFF the unit. Hold down the  whilst switching ON the unit to Unlock.

Master Reset

All settings can be reset to the default factory set up by pressing the  

keys while turning the unit on with the  button.

Dimensions

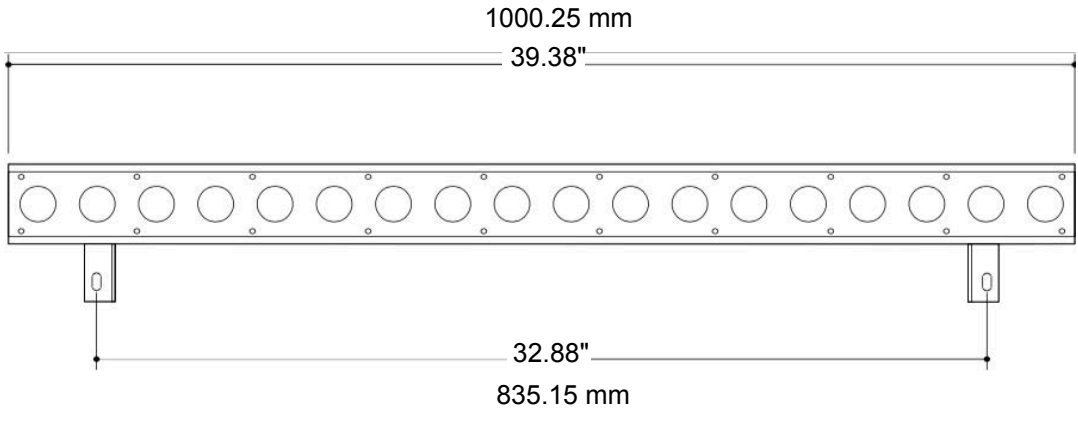
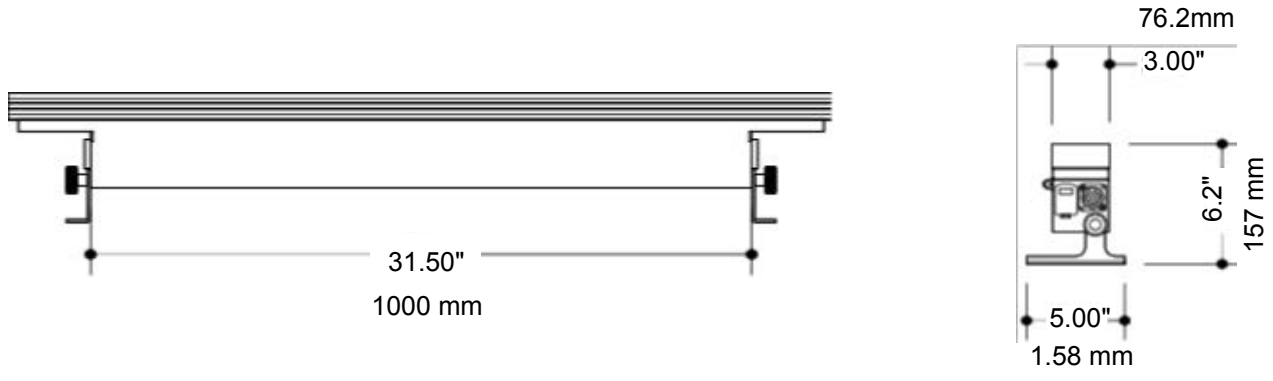

Mechanical

Dimensions

Length : 1000mm

Height: 157mm (with feet attached)

Width: 74mm

Weight: 6.0Kg

Floor mounting: the unit can be pivoted through 90 degrees providing vertical and horizontal beams

Truss mounting options: The unit is supplied with Adjustable feet designed to be attached to standard 10mm mountings. Alternatively the QolorStrip can be attached to a baseplate using quick-release, ¼ turn fixings available from City Theatrical Inc. This baseplate has 10mm fixings to be attached to trussing walls or other structures.

Safety Fixings: the QolorStrip has 10mm eyes in the back of the chassis and M10 blind mountings allowing a range of safety clips to be attached

Antenna

The antenna is a high-gain type similar in performance to the Wireless Solutions W-DMX 2dB standard antenna according to testing. This antenna is now fitted to all City Theatrical Inc. units.

Appendix 1 – DMX Mapping Table

DMX CHANNEL	Rx DMX MODE (selected in SETTINGS menu)				
	4 channel	5 channel	8 channel	9 channel	72 channel
1	RED on all pixels	RED on all pixels	RED on pixels 1-9	RED on pixels 1-9	R on Pixel 1
2	GREEN on all pixels	GREEN on all pixels	GREEN on pixels 1-9	GREEN on pixels 1-9	G on Pixel 1
3	BLUE on all pixels	BLUE on all pixels	BLUE on pixels 1-9	BLUE on pixels 1-9	B on Pixel 1
4	WHITE on all pixels	WHITE on all pixels	WHITE on pixels 1-9	WHITE on pixels 1-9	W on Pixel 1
5		DIMMER on all pixels	RED on pixels 10 - 18	RED on pixels 10 - 18	R on Pixel 2
6			GREEN on pixels 10 -18	GREEN on pixels 10 -18	G on Pixel 2
7			BLUE on pixels 10-18	BLUE on pixels 10-18	B on Pixel 2
8			WHITE on pixels 10-18	WHITE on pixels 10-18	W on Pixel 2
9				DIMMER on all pixels	R on Pixel 3
10					G on Pixel 3
11					B on Pixel 3
12					W on Pixel 3
13					R on Pixel 4
14					G on Pixel 4
15					B on Pixel 4
16					W on Pixel 4
.					.
.					.
.					.
.					.
.					.
61					R on Pixel 16
62					G on Pixel 16
63					B on Pixel 16
64					W on Pixel 16
65					R on Pixel 17
66					G on Pixel 17
67					B on Pixel 17
68					W on Pixel 17
69					R on Pixel 18
70					G on Pixel 18
71					B on Pixel 18
72					W on Pixel 18

Warranty

City Theatrical Incorporated (City Theatrical) warrants this product to be free from defects in materials and workmanship (subject to the terms set forth below).

City Theatrical will repair or replace (at City Theatrical's option) this product or any defective parts in this product. The standard warranty period is 12 months from date of purchase, although this period may vary from country to country. If in doubt consult your dealer and ensure that you retain proof of purchase.

To obtain warranty service, please contact the City Theatrical authorized dealer from which you purchased this product. If your dealer is not equipped to perform the repair of your City Theatrical product, it can be returned directly to City Theatrical, with carriage being paid at your own expense. You will need to ship this product in either its original packaging or packaging affording an equal degree of protection. Providing the product is found to be faulty, City Theatrical will pay for return carriage.

Proof of purchase in the form of a bill of sale or receipted invoice, which is evidence that this product is within the warranty period, must be presented to obtain warranty service.

This Warranty is invalid if (a) the factory-applied serial number has been altered or removed from this product or (b) this product was not purchased from a City Theatrical authorized dealer.

This Warranty does not cover cosmetic damage or damage due to acts of God, accident, misuse, abuse, negligence, or modification of, or to any part of, the product. This Warranty does not cover damage due to improper operation, maintenance or installation, or attempted repair by anyone other than City Theatrical or a City Theatrical dealer, or authorized service agent which is authorized to do City Theatrical warranty work. Any unauthorized repairs will void this Warranty. This Warranty does not cover products sold AS IS or WITH ALL FAULTS.

REPAIRS OR REPLACEMENTS AS PROVIDED UNDER THIS WARRANTY ARE THE EXCLUSIVE REMEDY OF THE CONSUMER. CITY THEATRICAL SHALL NOT BE LIABLE FOR ANY INCIDENTAL OR CONSEQUENTIAL DAMAGES FOR BREACH OF ANY EXPRESS OR IMPLIED WARRANTY IN THIS PRODUCT. EXCEPT TO THE EXTENT PROHIBITED BY LAW, THIS WARRANTY IS EXCLUSIVE AND IN LIEU OF ALL OTHER EXPRESS AND IMPLIED WARRANTIES WHATSOEVER INCLUDING, BUT NOT LIMITED TO, THE WARRANTY OF MERCHANTABILITY AND FITNESS FOR A PRACTICAL PURPOSE.

For any service, in or out of warranty, please contact your dealer.