

---

# Operation Manual

## 4Bank, Double & Single

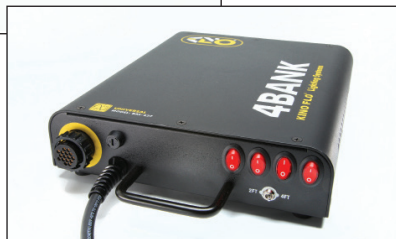

**KINO FLO®**  
Lighting Systems

# Systems

**4Bank**

**Double**

**Single**

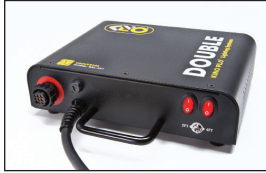

**Each System consists of:**

- 1 Fixture
- 1 Mounting Plate
- 1 Extension Cable
- 1 Ballast

## True Match® Lamps



- |                     |                         |
|---------------------|-------------------------|
| <b>488-K32-S/6P</b> | 4ft Kino KF32 (1 x 6pk) |
| <b>488-K55-S/6P</b> | 4ft Kino KF55 (1 x 6pk) |
| <b>242-K32-S/6P</b> | 2ft Kino KF32 (1 x 6pk) |
| <b>242-K55-S/6P</b> | 2ft Kino KF55 (1 x 6pk) |

# Lighting Kits



**Gaffer Kit**

**KIT-2GF-120U**

Gaffer Kit, Univ 120U (2-Unit)

**KIT-2GF-230U**

Gaffer Kit, Univ 230U (2-Unit)

**Kit Contents:**

- 2 4ft 4Bank System  
w/ MTP-BC41 Mount
- 2 Lamp Case
- 1 Gaffer Ship Case

**Dimensions:**

56.5 x 13 x 21.5"  
(143.5 x 33 x 55cm)

**Weight:**

72.5 lb  
(33kg)



**4ft 4Bank Kit**

**KIT-484B-120U**

4ft 4Bank Kit, Univ 120U (1-Unit)  
w/ Soft Case

**KIT-484B-230U**

4ft 4Bank Kit, Univ 230U (1-Unit)  
w/ Soft Case

**Kit Contents:**

- 1 4ft 4Bank System  
w/ MTP-BC41 Mount
- 1 Lamp Case
- 1 Soft Case

**Dimensions:**

55 x 8 x 19.5"  
(140 x 20.5 x 49.5cm)

**Weight:**

25.5 lb  
(12kg)

# Lighting Kits



**Interview Kit (2-Unit)**

**KIT-2NT-120U**

Interview Kit, Univ 120U (2-Unit)

**KIT-2NT-230U**

Interview Kit, Univ 230U (2-Unit)

**Kit Contents:**

- 2 2ft 4Bank System w/ MTP-BC41 Mount
- 2 Lamp Case
- 1 Interview Ship Case

**Dimensions:**

35.5 x 13 x 22"  
(90 x 33 x 56cm)

**Weight:**

56.5 lb  
(26kg)



**2ft 4Bank Kit**

**KIT-244B-120U**

2ft 4Bank Kit, Univ 120U (1-Unit)  
w/ Soft Case

**KIT-244B-230U**

2ft 4Bank Kit, Univ 230U (1-Unit)  
w/ Soft Case

**Kit Contents:**

- 1 2ft 4Bank System w/ MTP-BC41 Mount
- 1 Lamp Case
- 1 Soft Case

**Dimensions:**

28.5 x 7.5 x 20"  
(72.5 x 19 x 51cm)

**Weight:**

20 lb  
(9kg)



**Interview Kit (3-Unit)**

**KIT-3NT-120U**

Interview Kit, Univ 120U (3-Unit)

**KIT-3NT-230U**

Interview Kit, Univ 230U (3-Unit)

**Kit Contents:**

- 1 2ft 4Bank System w/ MTP-BC41 Mount
- 2 2ft Double System w/ MTP-BC41 Mount
- 2 Lamp Case
- 1 Interview Ship Case

**Dimensions:**

35.5 x 13 x 23"  
(90 x 33 x 58.5cm)

**Weight:**

63 lb  
(29kg)

# Fixture Assembly

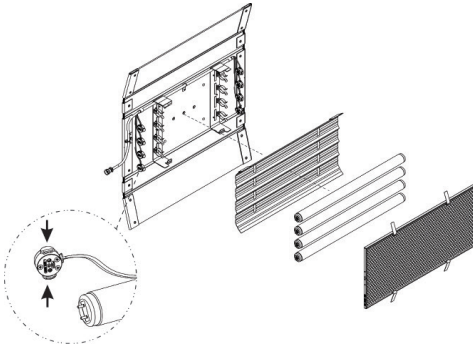

The 4Bank, Double and Single fixtures are comprised of a removable Louver, Reflector and Lamp Harness.

The Louver and Reflector are held in place with Velcro fasteners. The Lamp Harness is secured by means of a  $\frac{1}{4}$  turn fastener and two clips.



## To Release the Lamp Harness

Remove the harness from 2 clips located under the reflector. Rotate the  $\frac{1}{4}$  turn fastener clockwise to release harness.



The lamps can operate independent of the fixture allowing them to be built into sets or custom soft boxes or hand-held as a single tube for an eye-light.

**WARNING:** Always use safety-coated lamps to avoid injury if lamp breaks.

## Lamp Harness Color Codes

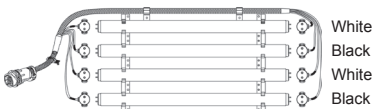

**4Bank Harness**

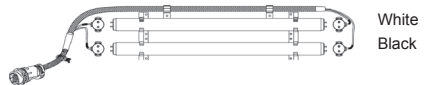

**Double Harness**

The Harness wiring is color-coded. The same color-code must match at each end of the lamp for proper operation.

## Inserting Lamps



### Locking Lamp Connector:

Depress both tabs on lamp connector and apply to lamp pins. Match the Harness color-codes at each end of the lamp. Push lamps into the fixture's Lamp Holder Clips.

## Gelling the Fixture



Restricting the airflow around the lamps can cause the lamps to operate hotter. This increased heat will raise the lamp's color temperature and green spike. Therefore, it is recommended to clip gels to the doors of the fixture.

**Remove Louver. Do Not** clip gels to louver.

**Do Not** block the fixture ends in a manner that restricts airflow.

# Mounting the Fixture



The standard mount (**MTP-KF41**) comes with a 3/8" Lollipop that clamps into a grip head. The ball and socket mount allows the fixture to be oriented in a broad range of angles.



Align the center pin of the mounting plate to the center hole on the mating plate.

Rotate plate clockwise until the four shoulder rivets drop into the receptacle. A locking pin will snap into place when the plate is properly seated.

The **yellow wire loops** provide attachment points for a safety chain.

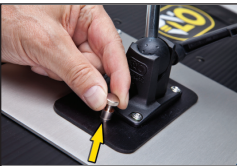

**To remove the plate**, pull up on the locking pin and reverse the mounting procedure.

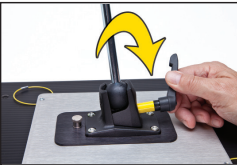

A 180° turn loosens the orientation of the mount. A right turn tightens the mount.



The tension on the lock lever may be adjusted by pulling the handle away from the mount.

This disengages the handle from the screw mechanism and allows the lever to be reoriented.

You can also use a screwdriver to adjust the tension. Pull back on handle and adjust screw.



Lollipops are interchangeable.

**MTP-L** Kino 41 Lollipop w/ 3/8" Pin (10mm)

**MTP-LBC** Kino 41 Lollipop w/ Baby Rcvr Curve (16mm)

**MTP-LBS** Kino 41 Lollipop w/ Baby Rcvr Short (16mm)

## Other Fixture Mounting Options



The grommet holes along the edge of the fixture are designed to allow the fixture to be screwed onto set walls.

## Ballast Operation

### **WARNING!**

- 1) ALWAYS TURN OFF THE BALLAST BEFORE connecting or disconnecting Lamps, Harnesses or Extension Cables.
- 2) Use only with Sine wave inverters. Do not operate on SCR dimmers.
- 3) If powering the ballasts through a Dimmer Pack, set the Dimmer to Non-Dim mode.

The Ballast requires 100-240VAC 50/60 Hertz on an earth grounded circuit; The electronic Ballast operates at a high frequency of 25kHz. It is dead-quiet, instant-on and lightweight.

### **Cold Temperature Operation**

The Ballast is designed to operate at temperatures from 14°F to 122°F (-10°C to +50°C). In cold temperatures, the Ballast may not strike the lamp(s) instantly. Switch the Ballast to OFF, wait seven seconds and try again. If the Ballast does not strike after two or three attempts, turn off the Ballast, check that the Extension and Harness connections are secure and re-strike. Once operating for a few minutes, the lamps should re-strike instantly.



The Ballast operates remote from the fixture. Connect the Extension cable to the Ballast and the Lamp Harness. After the lamps are properly installed, the Ballast can be turned on. Each switch controls one lamp. The color bands on the lamp harness correspond to the switches as illustrated.

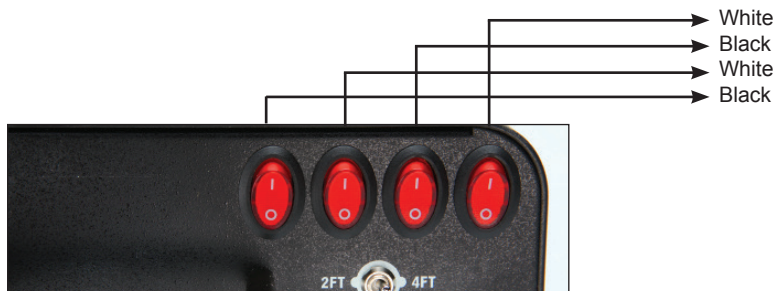

### Lamp Select Feature

The Ballasts have a **4ft/2ft** switch. Set the selector switch to **4ft** for 4ft lamps and **2ft** for 2ft lamps.

When operating 4ft lamps in high ambient temperature or where the units are rigged into place with restricted airflow, the **2ft** setting can be used to lower the color temperature and remove any green spike. The light drops about a half an f-stop in exposure when dropping from **4ft** to **2ft**.

It is not recommended to operate 2ft lamps in the **4ft** setting. At the **4ft** setting, the color temperature of the 2ft lamps will rise dramatically and experience a high green spike.

## Extension Cable



To insert the cable, position the logo up to align the key ways on the extension cable with the circular receptacle on the ballast. Rotate the locking ring until it clicks into the lock position.

Lamps can operate as far as 75 feet from the ballast.  
(3 x 25ft extensions)



A **Splitter** can be used at the Ballast or on the end of an Extension Cable to split a 4Bank run into either four Singles or two Doubles. This allows for greater rigging flexibility.

# System Components



- CFX-484** 4ft 4Bank Fixture w/ Louver/HP, 90°
- CFX-4802** 4ft Double Fixture
- CFX-4801** 4ft Single Fixture
- CFX-244** 2ft 4Bank Fixture w/ Louver/HP, 90°
- CFX-2402** 2ft Double Fixture
- CFX-2401** 2ft Single Fixture



- MTP-KF41** Kino 41F Mount w/ 3/8" Pin (10mm)



- X16-25** 4Bank Extension Cable, 25ft
- X09-25** Double Extension Cable, 25ft
- X04-25** Single Extension Cable, 25ft



- BAL-427-120U** 4Bank Ballast, Univ 120U
- BAL-427-230U** 4Bank Ballast, Univ 230U
- BAL-227-120U** Double Ballast, Univ 120U
- BAL-227-230U** Double Ballast, Univ 230U
- BAL-127-120U** Single Ballast, Univ 120U
- BAL-127-230U** Single Ballast, Univ 230U

# True Match® Lamps



- 488-K32-S/6P** 4ft Kino KF32 (1 x 6pk)
- 488-K55-S/6P** 4ft Kino KF55 (1 x 6pk)
- 242-K32-S/6P** 2ft Kino KF32 (1 x 6pk)
- 242-K55-S/6P** 2ft Kino KF55 (1 x 6pk)

# Accessories and Parts



**DFS-4804** 4ft 4Bank Flozier, Full  
**DFS-4804-H** 4ft 4Bank Flozier, Half  
**DFS-D4** 2ft 4Bank Flozier, Full  
**DFS-D4-H** 2ft 4Bank Flozier, Half  
**DFS-D2** 2ft Double Flozier, Full



**FIX-484** 4ft 4Bank Fixture Shell  
**FIX-4802** 4ft Double Fixture Shell  
**FIX-4801** 4ft Single Fixture Shell  
**FIX-244** 2ft 4Bank Fixture Shell  
**FIX-2402** 2ft Double Fixture Shell  
**FIX-2401** 2ft Single Fixture Shell



**HAR-4804** 4ft 4Bank Harness  
**HAR-4802** 4ft Double Harness  
**HAR-4801** 4ft Single Harness  
**HAR-2404** 2ft 4Bank Harness  
**HAR-2402** 2ft Double Harness  
**HAR-2401** 2ft Single Harness

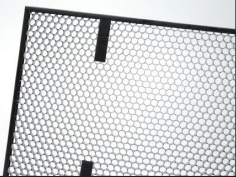

**LVR-K490-P** 4ft 4Bank Louver/HP, 90°  
**LVR-K290-P** 2ft 4Bank Louver/HP, 90°

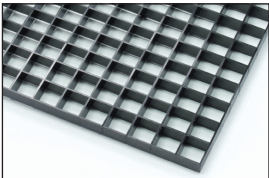

**LVR-4802-B** 4ft Double Louver, Black  
**LVR-4801-B** 4ft Single Louver, Black  
**LVR-2402-B** 2ft Double Louver, Black  
**LVR-2401-B** 2ft Single Louver, Black

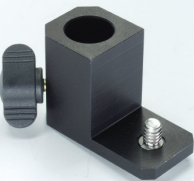

**MTP-BAL** Kino Ballast Baby Mount (16mm)



**MTP-BC41** Kino 41K Mount w/ Baby Receiver Curve (16mm)

**MTP-BF41S** Kino 41K Mount w/ Baby Rcvr Short (16mm)



**MTP-L** Kino 41 Lollipop w/ 3/8" Pin (10mm)

**MTP-LBC** Kino 41 Lollipop w/ Baby Rcvr Curve (16mm)

**MTP-LBS** Kino 41 Lollipop w/ Baby Rcvr Short (16mm)

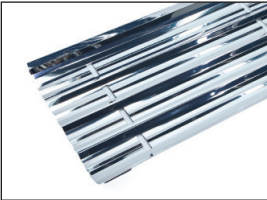

**REF-4804** 4ft 4Bank Reflector

**REF-4802** 4ft Double Reflector

**REF-4801** 4ft Single Reflector

**REF-2404** 2ft 4Bank Reflector

**REF-2402** 2ft Double Reflector

**REF-2401** 2ft Single Reflector



**X16-12** 4Bank Extension Cable, 12ft



**X16-A4** 4Bank to Single Splitter

**X16-A9** 4Bank to Double Splitter

**X09-A4** Double to Single Splitter

# Expendables

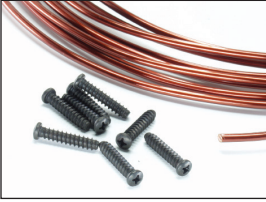

**EXP-FXR-S** Fixture Wire Repair Kit (Silver)



**EXP-LHC-T12** Lamp Holder Clips, T12 (24pk)



**EXP-M&T** Adhesive Mounts & Releasable Ties (25pk)



**PRT-CR4** 4Bank Connector Locking Ring (4pk)  
**PRT-CR2** Double Connector Locking Ring (4pk)  
**PRT-CR1** Single Connector Locking Ring (4pk)



**PRT-HLC** Kino Locking Lamp Connector (1pk)  
**PRT-HLC/50PK** Kino Locking Lamp Connector (50pk)

See our website at [www.kinoflo.com](http://www.kinoflo.com) for more repair parts.

# Cases



**KAS-C46**

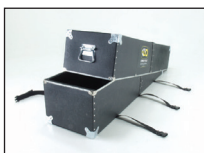

**KAS-54L**



**KAS-KFC**



**BAG-201**

Part Number	Description	Dimensions	Weight (Empty)	Holds
<b>BAG-201</b>	2ft 4Bank Soft Case	28 x 7.5 x 20" (72.5 x 19 x 51cm)	3.5 lb (2kg)	2ft 4Bank System (1), Lamp Case
<b>BAG-401</b>	4ft 4Bank Soft Case	55 x 8 x 19.5" (140 x 20.5 x 49.5cm)	6 lb (3kg)	4ft 4Bank System (1), Lamp Case
<b>INS-L4</b>	4-Lamp Foam Pad	24 x 9 x 1" (61 x 23 x 2.5cm)	N/A	Fits KAS-48, 72, 96
<b>INS-L6</b>	6-Lamp Foam Pad	24 x 13 x 1" (61 x 33 x 2.5cm)	N/A	Fits KAS-54S, 54L, 96L
<b>KAS-48</b>	4ft Lamp Ship Case	52.5 x 11 x 12" (133.5 x 28 x 30.5cm)	16 lb (7.5kg)	4ft Lamps (20)
<b>KAS-54L</b>	4ft Fixture Ship Case, Large	57.5 x 15 x 17" (146 x 38 x 43cm)	25.5 lb (12kg)	4ft 4Bank Fixtures (5)
<b>KAS-54S</b>	4ft Fixture Ship Case, Small	57.5 x 15 x 12" (146 x 38 x 30.5cm)	21 lb (9.5kg)	4ft 4Bank Fixtures (3)
<b>KAS-C26</b>	6-Lamp Carry Case (2ft)	26.5 x 6 x 4" (67.5 x 15 x 10cm)	1 lb (.5kg)	2ft Lamps (6)
<b>KAS-C46</b>	6-Lamp Carry Case (4ft)	50.5 x 6 x 4" (128.5 x 15 x 10cm)	1.5 lb (.7kg)	4ft Lamps (6)
<b>KAS-GAF2</b>	Gaffer Kit Ship Case	56.5 x 13 x 21.5" (143.5 x 33 x 55cm)	32 lb (14.5kg)	4ft 4Bank System (2), Lamp Case (2)
<b>KAS-INT2</b>	Interview Kit Ship Case (2)	35.5 x 13 x 22" (90 x 33 x 56cm)	25 lb (11.5kg)	2ft 4Bank System (2), Lamp Case (2)
<b>KAS-INT3</b>	Interview Kit Ship Case (3)	35.5 x 13 x 23" (90 x 33 x 58.5cm)	26 lb (12kg)	2ft 4Bank System, 2ft Double System (2), Lamp Case (2)
<b>KAS-KFC</b>	Ballast & Cable Crate w/ Lid	21.5 x 15 x 12" (54.5 x 38 x 30.5cm)	6 lb (3kg)	Ballasts, Cables, Mounting Plates

# Ballast Specifications



**4Bank**

## **BAL-427-120U** 4Bank Ballast, Univ 120U

**Input Voltage:** 100~240VAC 50/60Hz  
**Output Frequency:** 25kHz  
**Amperage:** F75/2.6A, F40/2.5A,  
F30/1.6A, F20/0.9A  
**Lamp Switching:** 1~4  
**Output Switching:** 4ft / 2ft  
**Ballast Size:** 13 x 9.5 x 3"  
(33 x 24 x 7.6cm)  
**Weight:** 4.9lb (2.2kg)

## **BAL-427-230U** 4Bank Ballast, Univ 230U

**Input Voltage:** 240~100VAC 50/60Hz  
**Output Frequency:** 25kHz  
**Amperage:** F75/1.4A, F40/1.3A,  
F30/0.8A, F20/0.7A  
**Lamp Switching:** 1~4  
**Output Switching:** 4ft / 2ft  
**Ballast Size:** 13 x 9.5 x 3"  
(33 x 24 x 7.6cm)  
**Weight:** 4.9lb (2.2kg)



**Double**

## **BAL-227-120U** Double Ballast, Univ 120U

**Input Voltage:** 100~240VAC 50/60Hz  
**Output Frequency:** 25kHz  
**Amperage:** F75/1.3A, F40/1.2A,  
F30/0.7A, F20/0.5A  
**Lamp Switching:** 1~2  
**Output Switching:** 4ft / 2ft  
**Ballast Size:** 9 x 9.5 x 3"  
(23 x 24 x 7.6cm)  
**Weight:** 3.3lb (1.5kg)

## **BAL-227-230U** Double Ballast, Univ 230U

**Input Voltage:** 240~100VAC 50/60Hz  
**Output Frequency:** 25kHz  
**Amperage:** F75/0.7A, F40/0.7A,  
F30/0.4A, F20/0.3A  
**Lamp Switching:** 1~2  
**Output Switching:** 4ft / 2ft  
**Ballast Size:** 9 x 9.5 x 3"  
(23 x 24 x 7.6cm)  
**Weight:** 3.3lb (1.5kg)



**Single**

**BAL-127-120U** Single Ballast, Univ 120U

**Input Voltage:** 100~240VAC 50/60Hz  
**Output Frequency:** 25kHz  
**Amperage:** F75/0.6A, F40/0.6A,  
F30/0.4A, F20/0.2A  
**Lamp Switching:** 1~off  
**Output Switching:** 4ft / 2ft  
**Ballast Size:** 9.5 x 4 x 3"  
(24 x 10 x 7.6cm)  
**Weight:** 2.1lb (1.0kg)

**BAL-127-230U** Single Ballast, Univ 230U

**Input Voltage:** 240~100VAC 50/60Hz  
**Output Frequency:** 25kHz  
**Amperage:** F75/0.3A, F40/0.3A,  
F30/0.2A, F20/0.2A  
**Lamp Switching:** 1~off  
**Output Switching:** 4ft / 2ft  
**Ballast Size:** 9.5 x 4 x 3"  
(24 x 10 x 7.6cm)  
**Weight:** 2.1lb (1.0kg)

For latest Warranty information and Certifications,  
see Kino Flo website at [www.kinoflo.com](http://www.kinoflo.com).

**Environmental: Disposal of Old Electrical & Electronic Equipment.**



This symbol on the product or on its packaging indicates that this product shall not be treated as household waste. This product is made of recyclable materials and should be disposed of in accordance with local and state regulations.

---

Kino Flo, Inc. 2840 N. Hollywood Way, Burbank, CA 91505, USA  
Tel: 818 767-6528 website: [www.kinoflo.com](http://www.kinoflo.com)