

RGBW

Beam opening  
(m)

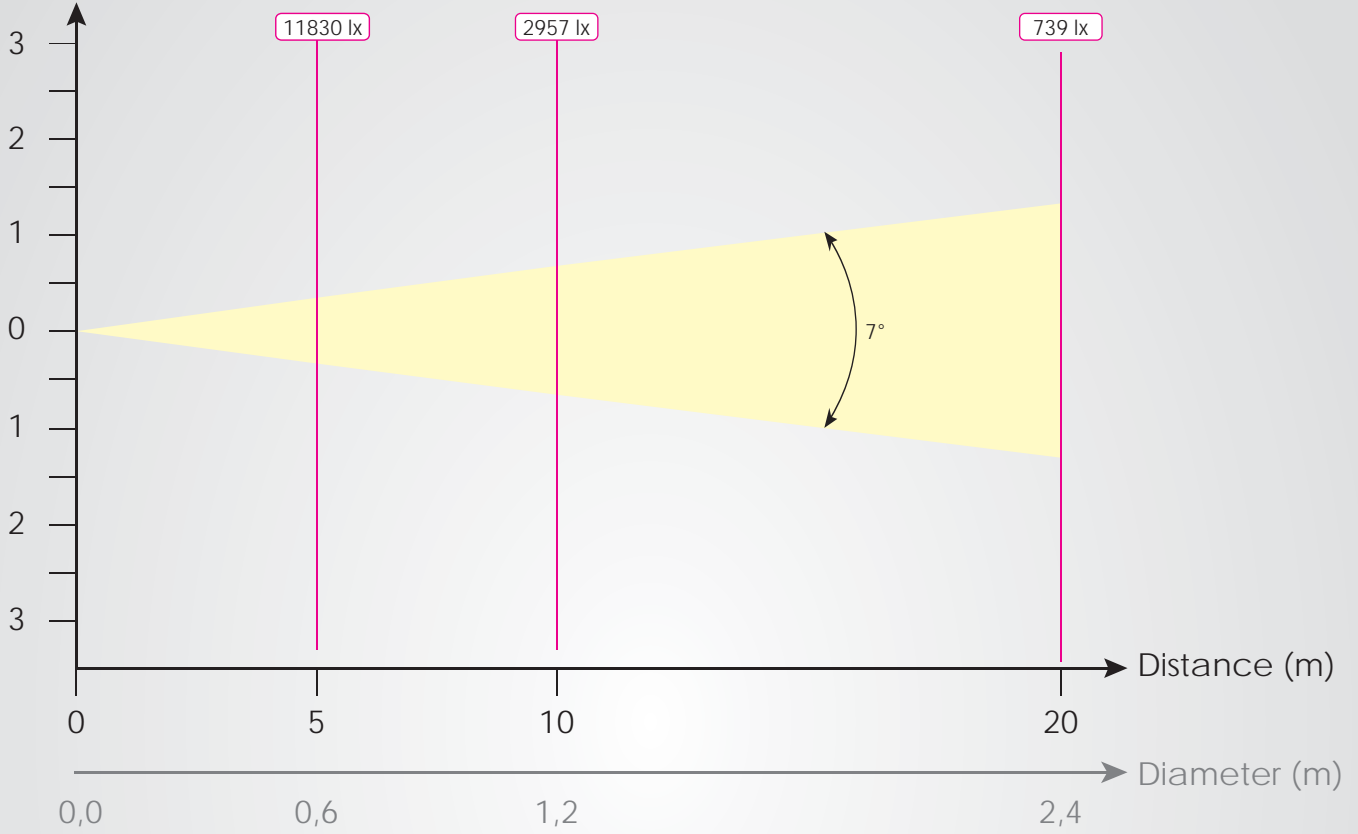

R

Beam opening  
(m)

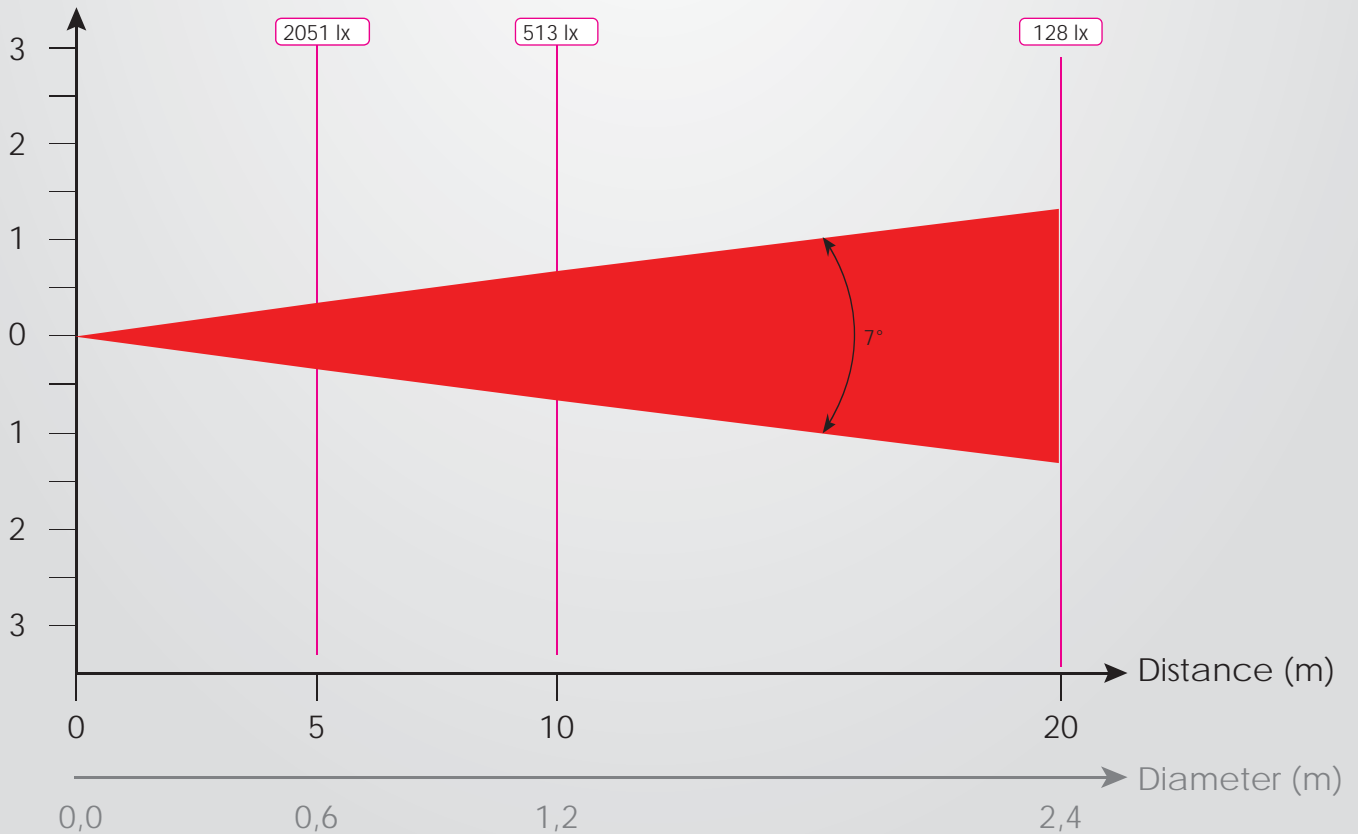

**G**

Beam opening  
(m)

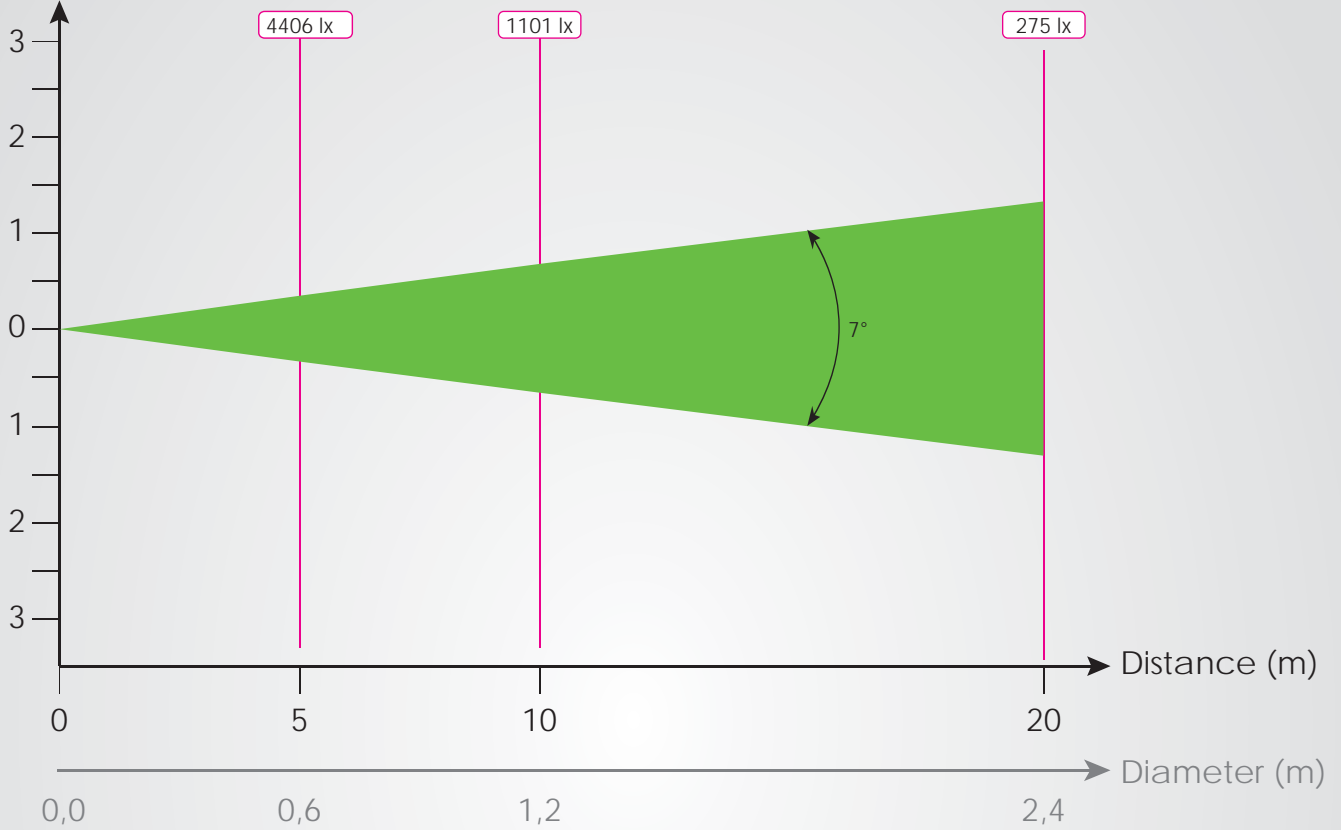

**B**

Beam opening  
(m)

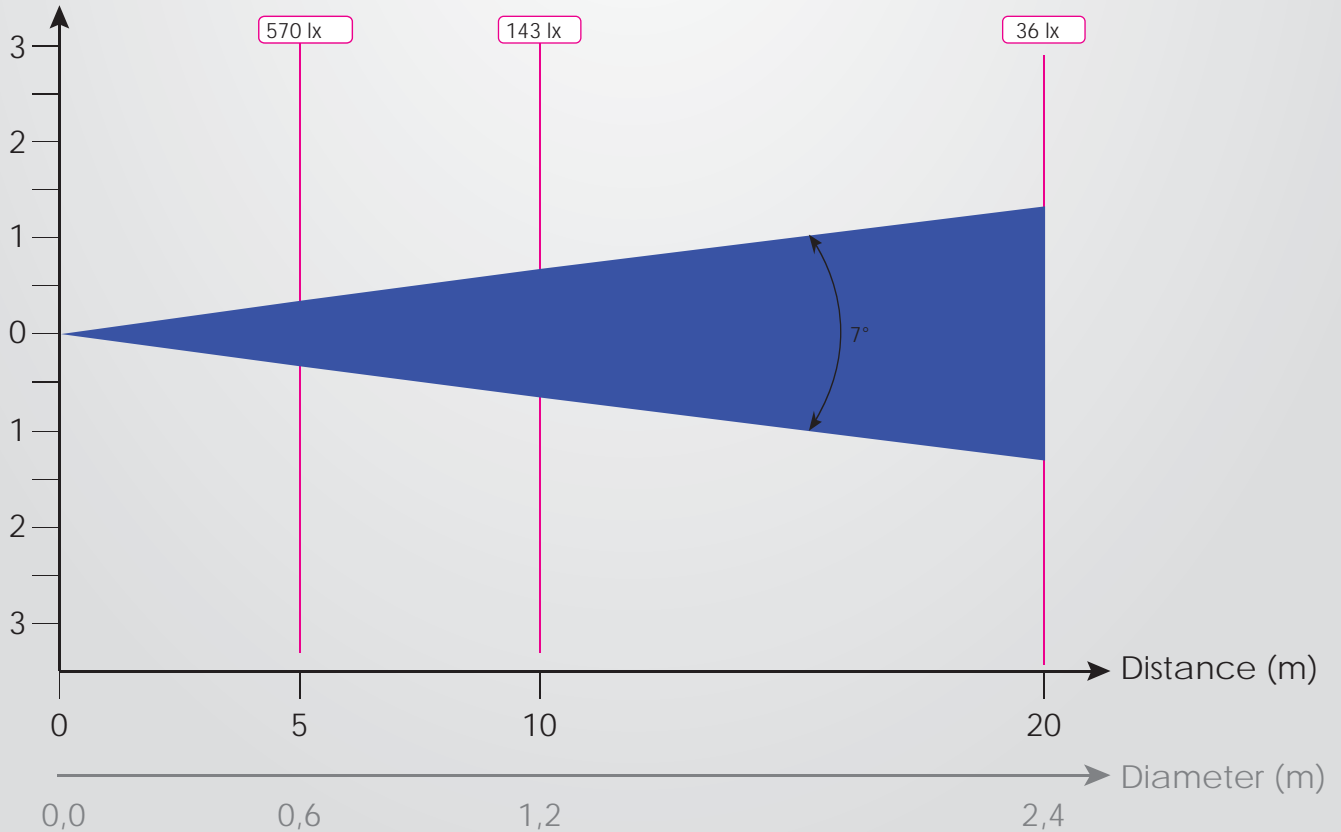

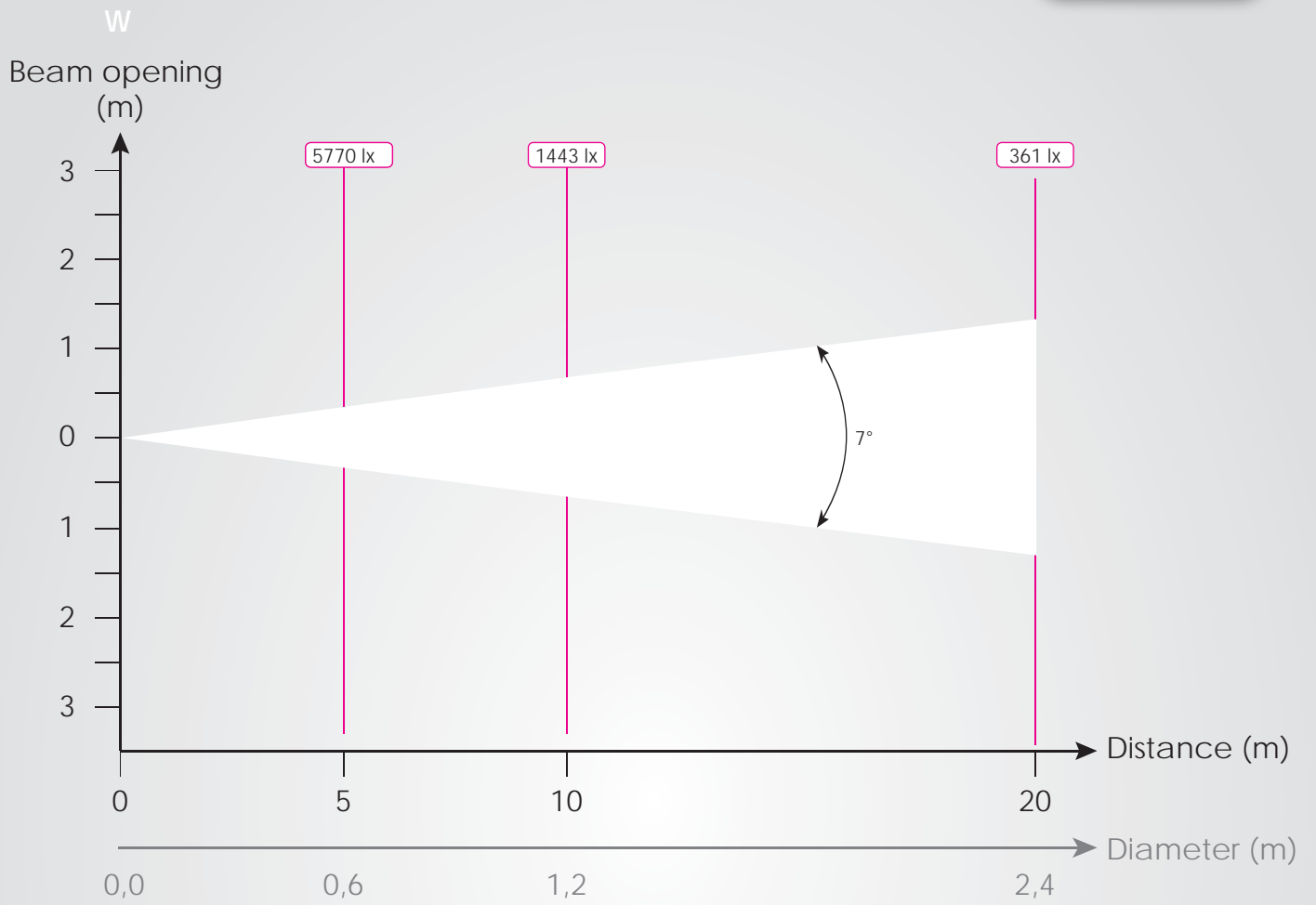

RGBW

Beam opening  
(m)

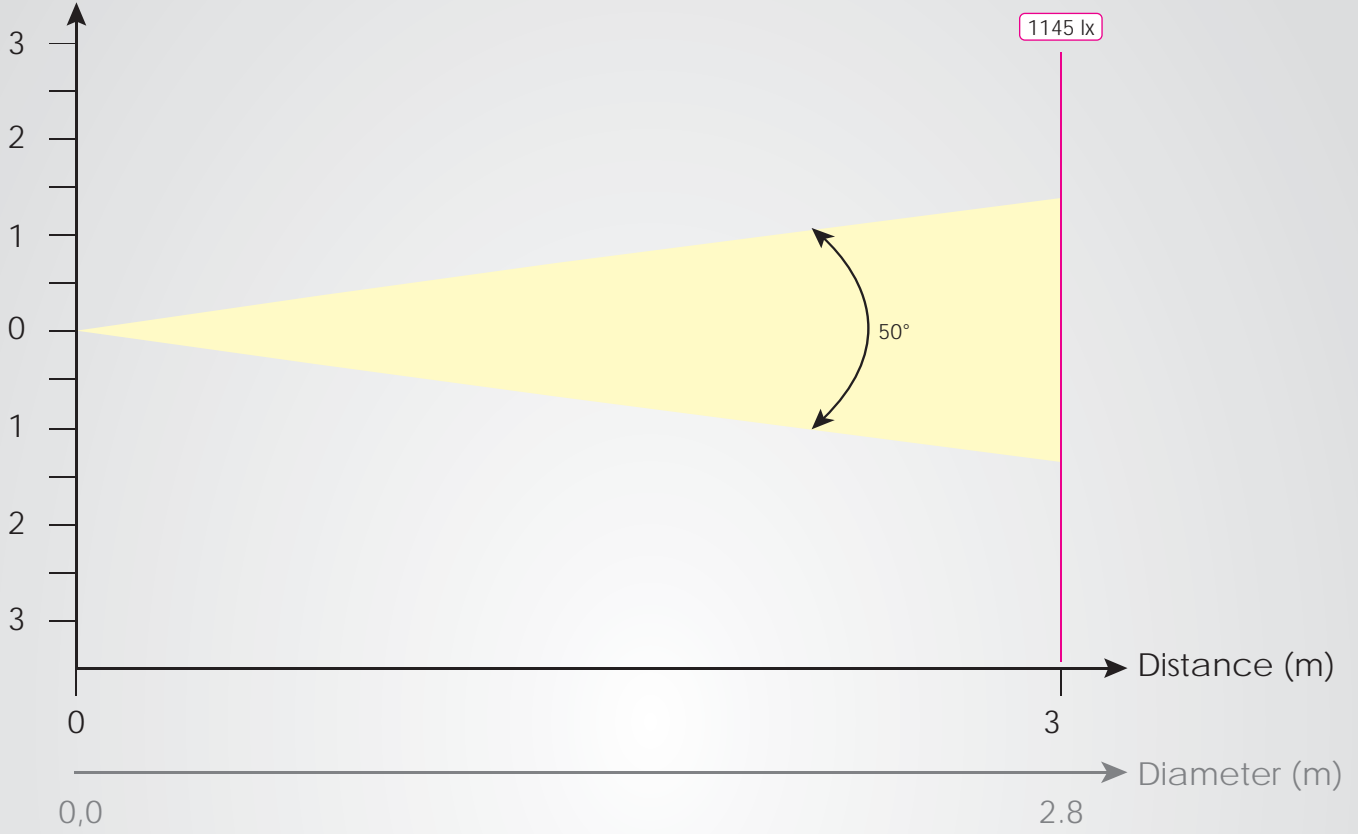

R

Beam opening  
(m)

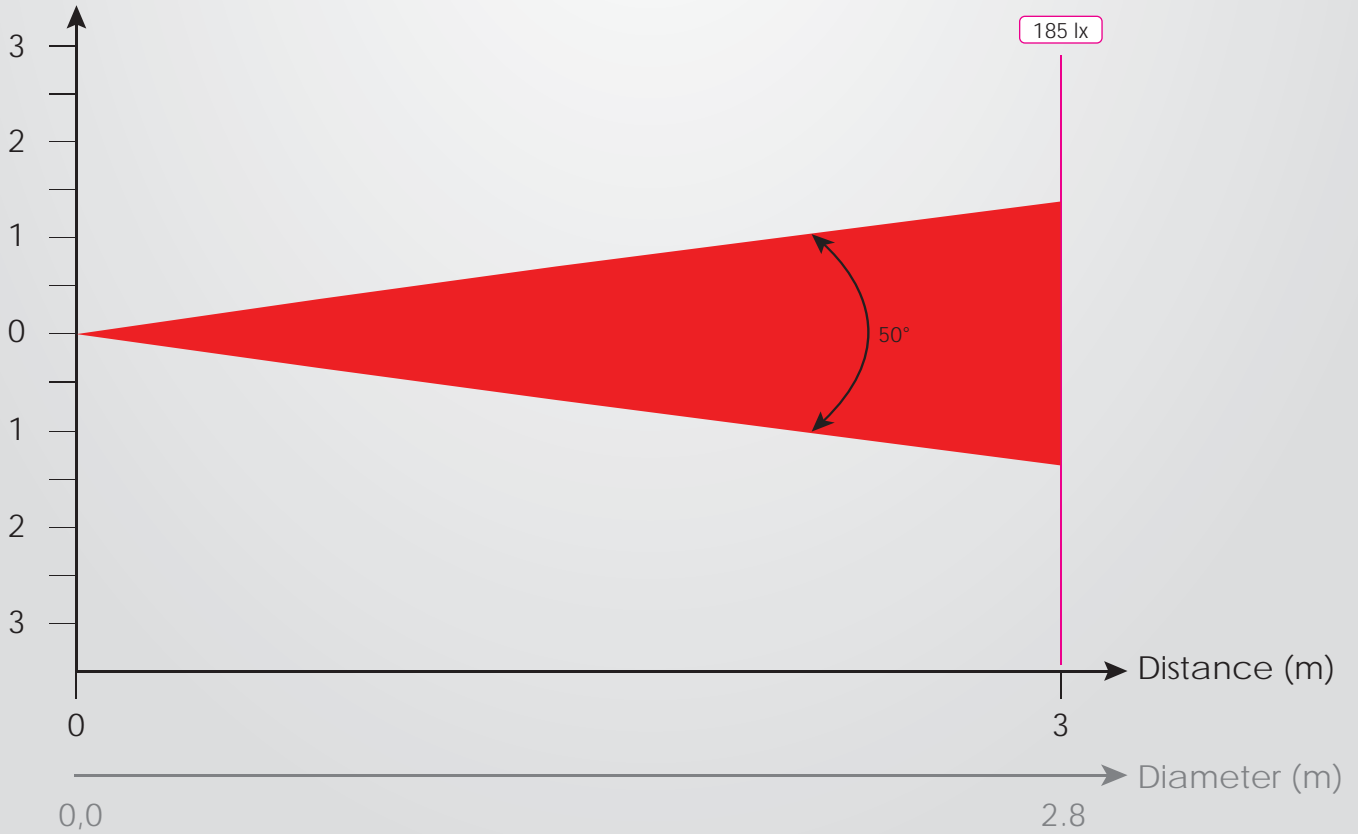

G

Beam opening  
(m)

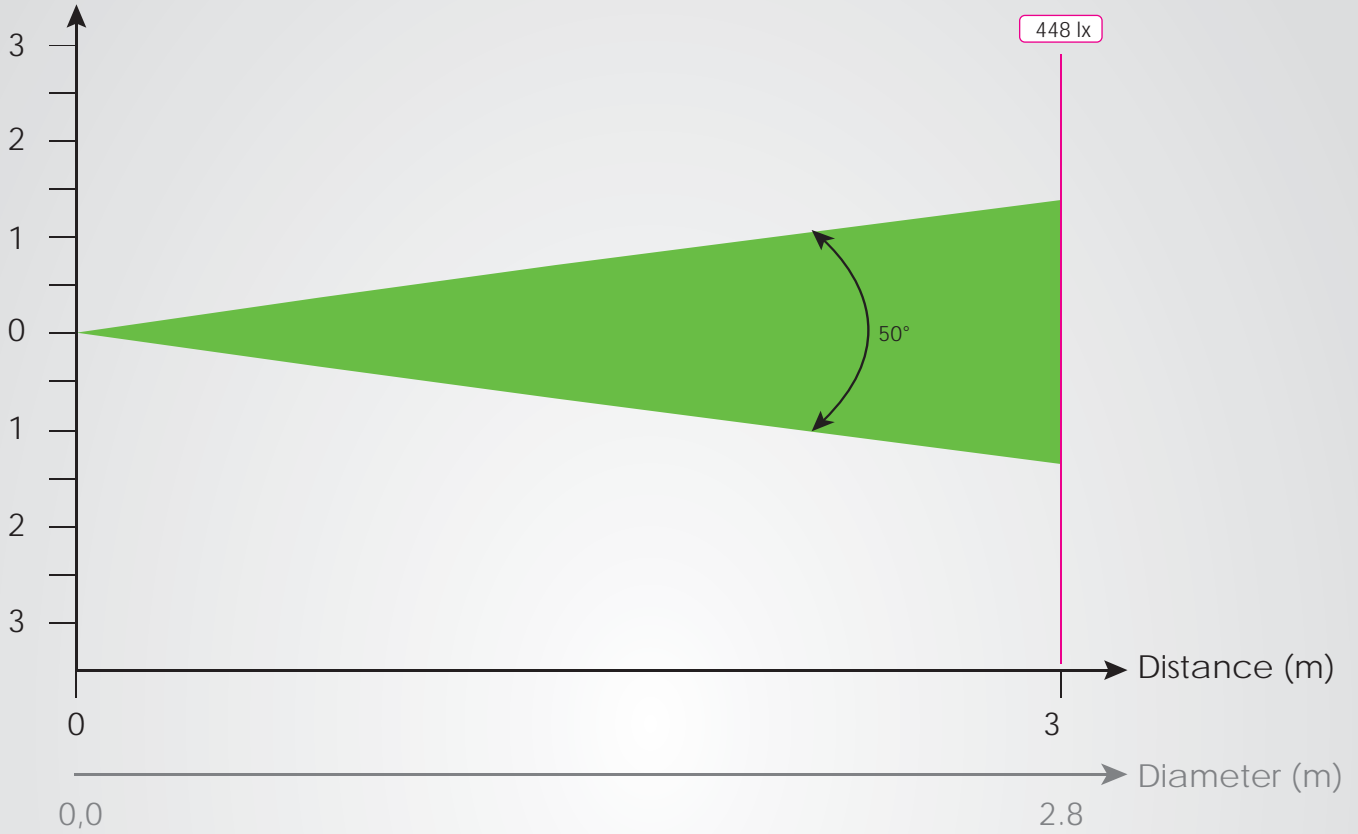

B

Beam opening  
(m)

