

100 Console

Operations Manual



Manual
Part No. 24-004-0816

Welcome

Thank you for buying Strand Lighting control equipment. We hope that you will find that your lighting needs are met by your new system and that you will enjoy exploring the new facilities that your new system offers. You are provided with essential information to help you install and operate your system. Please look through all the documents and keep them safely for future use. If you have any difficulties, please do not hesitate to contact Strand Lighting or any authorized Strand service center for advice.

This equipment is designed to operate from the mains electrical supply and contains voltages, which, if touched, may cause death or injury. It should only be operated in accordance with the instructions provided and for the purpose of a lighting control system.

Do not open the console. There are no user serviceable parts inside.

Avoid spilling liquid on the equipment. If this should happen, switch the equipment off immediately at the mains. To reduce the risk of fire or electric shock, do not expose the equipment to rain or moisture.

For indoor use only.

This equipment is designed and manufactured to comply with international safety standards IEC950, UL1950, CS950 and is intended for use as part of a lighting control system. It must not be used for other purposes where there is a risk of safety to persons. The equipment contains power voltages, socket outlets shall be installed near to the equipment and be easily accessible.

- Working Voltage/Current 100-120 (2A) 220-240 (1A)
- Frequency 50/60 Hz
- Max Ambient Temp 35°C
- Do not restrict ventilation

This manual describes the installation and operational procedures for Strand Lighting's 100 Control Console.

Offices and Service Centers

Phone numbers do not include country code or other international access data.

World Wide Web: <http://www.strandlighting.com/>

Berlin

Strand Lighting GMBH
Ullsteinstrasse. 114-142, HAUS C
D-12109
Berlin, Germany
Tel. +49-30-707-9510 Fax +49-30-707-95199

Hong Kong

Strand Lighting Asia LTD
20/F., Delta House
3 On Yiu Street
Shatin, N.T.
Hong Kong
Tel. +852-2757-3033 Fax +852-2757-1767

London

Strand Lighting Limited
Unit 3 Hammersmith Studios
Yeldham Road
Hammersmith
London, England W6 8JF
Tel. +44-20-8735-9790 Fax +44-20-8735-9799

Los Angeles

Strand Lighting Inc
6603 Darin Way
Cypress, CA 90630
U.S.A.
Tel. +1 714-230-8200 Fax +1 714-230-8173

Moscow

Strand Lighting
Novinsky Boulevard 20A Building 3-6
12069 Moscow, Russia
Tel. +7 095-234-42-20 Fax. +7 095-234 42-21

Rome

Strand Lighting Italia
Via Delle Gardenie S.N.C.
Pontina Vecchia KM 33,400
00040 Pomezia, Italy
Tel. +39-0691-9631 Fax +39-0691-47138

Toronto

Strand Lighting (Canada) Inc
2430 Lucknow Drive #15,
Mississauga, Ontario, L5S 1V3
Canada
Tel. +1 905-677-7130 Fax. +1 905-677-6859

Table of Contents

Welcome	2
Offices and Service Centers.....	3
Table of Contents.....	4
Getting Started.....	5
Concept	5
Ordering Information.....	5
Mechanical & Environmental Data.....	5
Standards Compliance	5
Unpack the Console	5
Face Plate	6
Back Plate	6
Connect Power	7
Connect DMX	7
Rack Mounting.....	8
Turning the Console On.....	8
Layout	9
Quick Guide	10
Operation	12
Two Scene Operation.....	12
Manual Crossfades.....	12
Timed Crossfades.....	12
Single Scene Operation.....	13
Hold	14
Effect – Single Scene Mode	15
Effect – Two Scene Mode.....	16
Conclusion	16
Appendix A.....	17
Control Input.....	17
Index	18

Getting Started

Concept

The Strand 100 series console is a small, simple to use, preset lighting desk. It can either control 24 channels in 1 scene or 12 channels in 2 scenes with the ability to expand scenes with the Hold feature. The console also has the ability to run a single effect. This console can be rack mounted.

Ordering Information

Catalog # 61312 – 100 series 12/24 console 120 volt
Catalog # 61313 – 100 series 12/24 console 230/240 volt
Catalog # 24-004-0816 - 100 series manual

Mechanical & Environmental Data

Weight: 2kg/4.5lb
Finish: Blue powder coat epoxy paint
Construction: Rigid folded sheet steel
Temperature: 0 – 35°C
Humidity Range: 0-90% non-condensing
Ingress Protection: IP20

Standards Compliance

All units are CE marked. 120 volt consoles include UL, cUL power supplies.

Unpack the Console

Unpack the console from the packaging and check that the following components are contained within. If any parts are missing, or damaged, please contact the carrier and your nearest Strand Lighting office.

List of Parts for North America...

100 series console
Power cable with UL power supply cable with US 2 pin connector.
Manual

List of Parts for Europe and Asia...

100 series console
Power cable with cUL power supply cable with
UK 2 pin connector and EU 2 pin connector
Manual

Face Plate

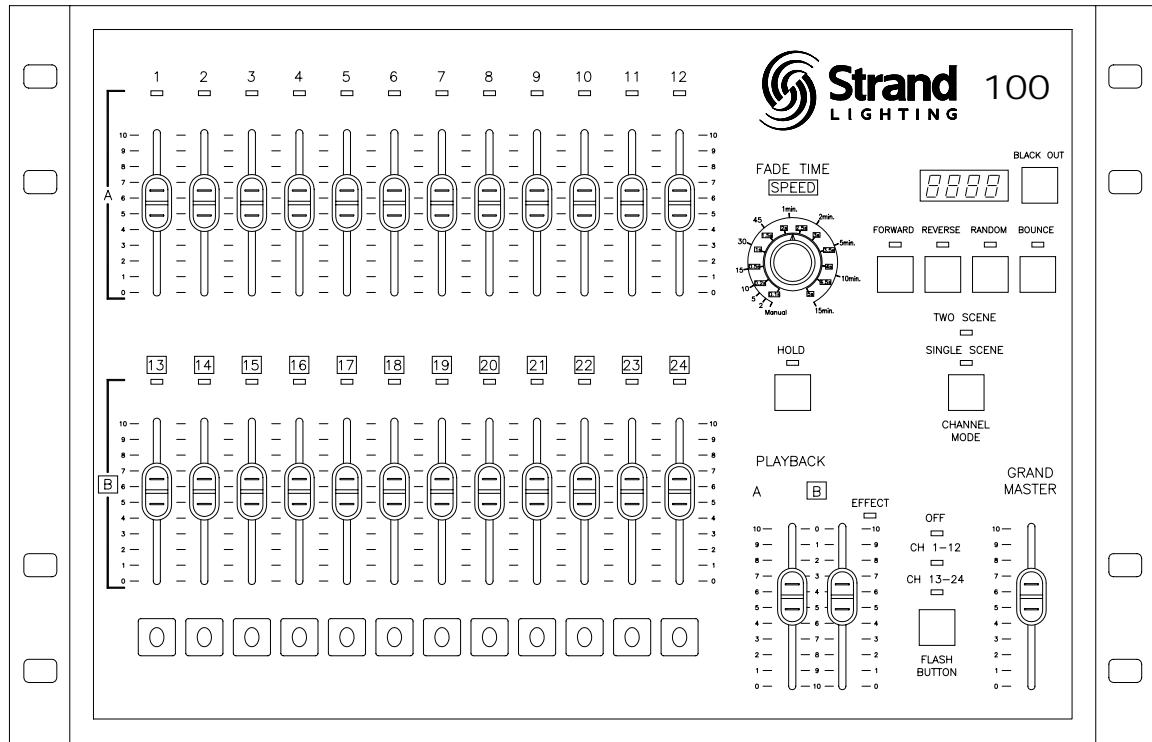

Back Plate

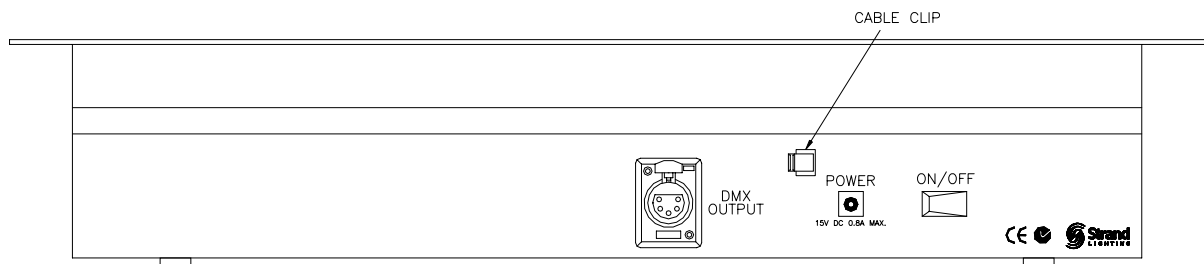

Connect Power

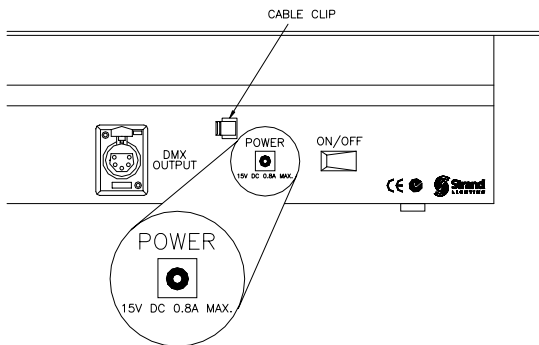

Connect the appropriate power cable to the power adapter and into the console. Connect the male end to the electrical service.

Connect DMX

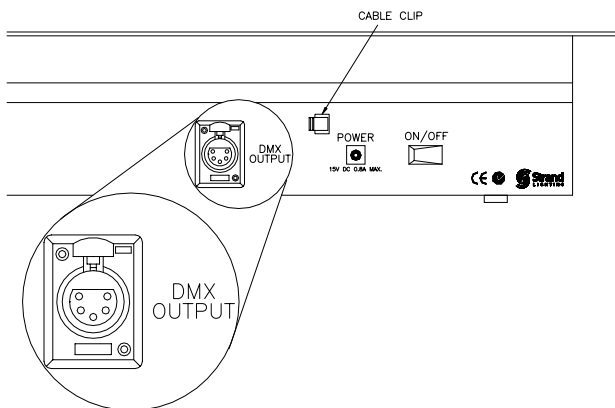

Connect the DMX cable from the dimmer rack input to the DMX output of the console.

(See Appendix A for complete DMX512 connector information.)

Rack Mounting

Below is a drawing that illustrates the removal of the edge pieces for rack mounting.

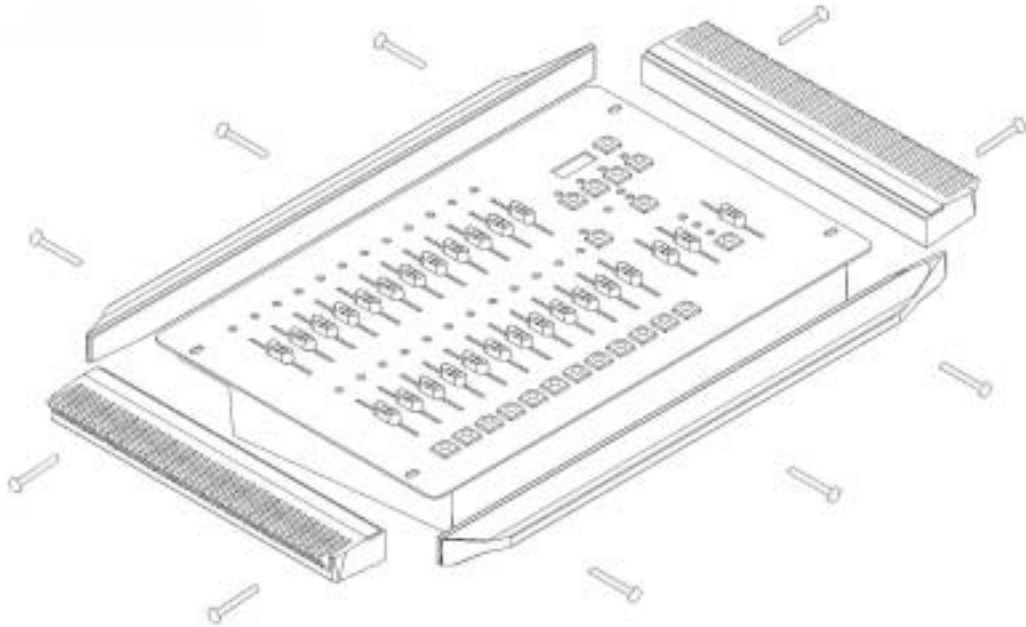

Turning the Console On

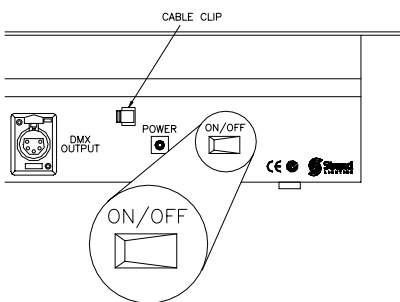

Switch the rocker switch to the ON position.

Layout

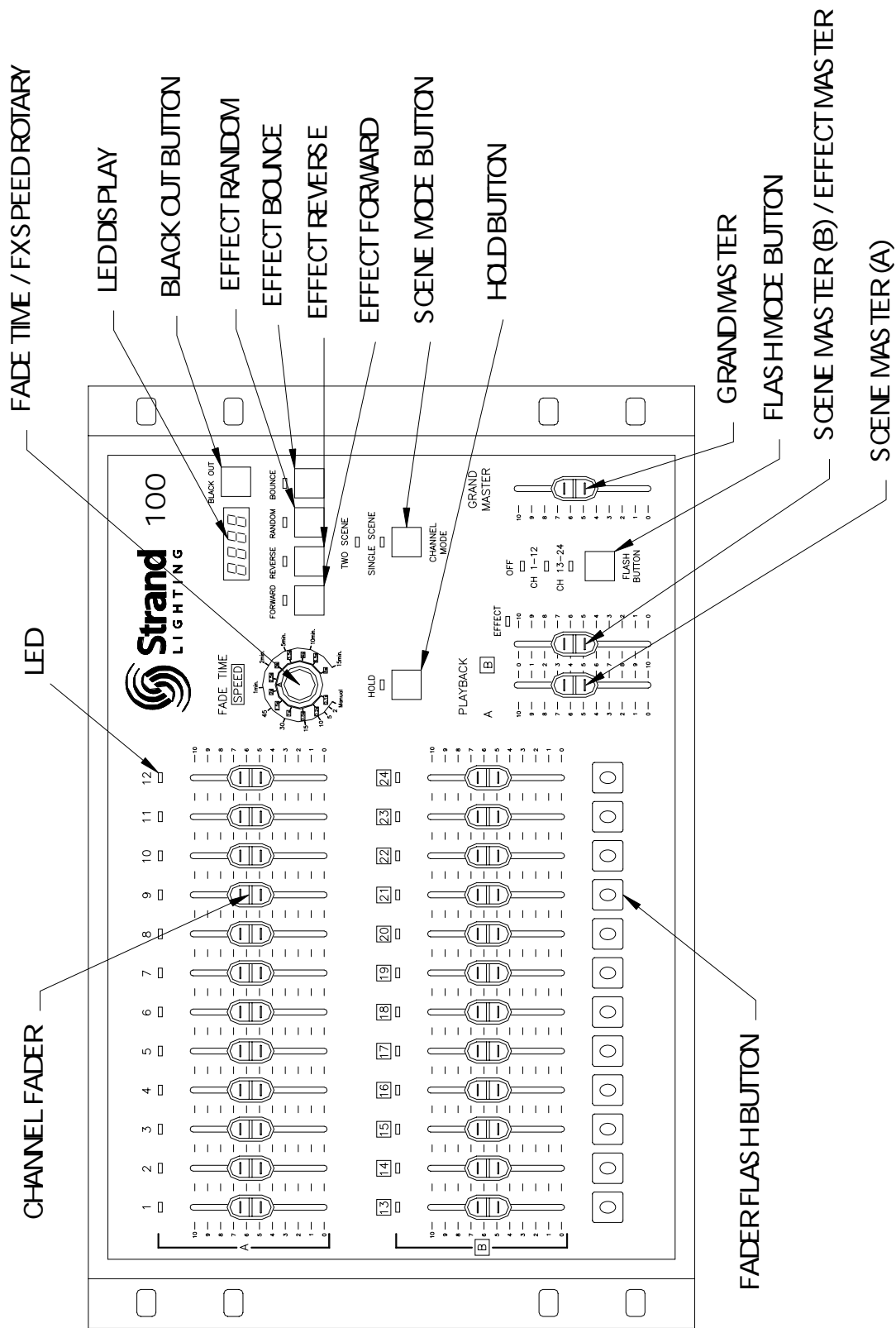

Quick Guide

Grand Master – an inhibitive fader that proportionately controls all other faders. This determines maximum output of all faders at all times. The grand master is always active.

Playback A – an inhibitive fader that proportionately controls all faders for the A scene.

Playback B / Effect Master – when not running the effect, an inhibitive fader that proportionately controls all faders for the B scene. When running the effect, the fader is a inhibitive master for the effect.

Channel Faders – a fader that controls the output of the corresponding dimmer number.

Fader Flash Buttons – a momentary button that flashes the level of the corresponding fader to full. Which fader is corresponding depends on the setting of the FLASH BUTTON. See below.

Mode Button – toggles between the two modes of operation of the console. 1 scene 24 channel mode or 2 scene 12 channel mode. The default is two scene mode.

Hold Button – this button will freeze the output of the faders so that the operator can reset the channel faders for a different look. This is only available in single scene mode.

Flash Button Mode Button – there are only 12 fader flash buttons and this button toggles the fader flash buttons between OFF, faders 1 – 12 and faders 13 – 24.

Fade Time / Effect Speed Dial – when not running the effect, this will allow the operator to set the fade time of the scene masters. When running the effect, this will allow the operator to set the rate at which the effect is running. See the LED display for time / speed readout.

Effect Options Buttons – these will allow the operator to change the stepping options of the effect.

Forward – this will allow the faders that have a level to step through their appropriate levels from the lowest number fader number to the highest.

Reverse – this will allow the faders that have a level to step through their appropriate levels from the highest number fader number to the lowest.

Random - this will allow the faders that have a level to step through their appropriate levels in a randomly generated order.

Bounce - this will allow the faders that have a level to step through their appropriate levels from the lowest number fader number to the highest then back to the lowest number fader.

LED Display – this will show alpha / numeric information about the console. Such as fade time, effect step rate and whether the black out button is active.

LED Lights – all channel faders have LEDs that mimic the output level of each fader. LEDs also are indicators of the channel mode as well as when all features are activated. All LEDs are green.

Black Out Button – this will allow the operator to instantly stop all fader output. Press again to restore fader output.

Operation

Two Scene Operation

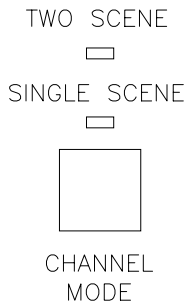

The first time you power up the console, it will default to two scene mode. The corresponding light will confirm that the console is in two scene mode.

Now playback A will be the scene master for the top bank of channel faders and playback B will be the scene master for the bottom bank of channel faders. These two banks of faders both correspond to dimmers 1 – 12.

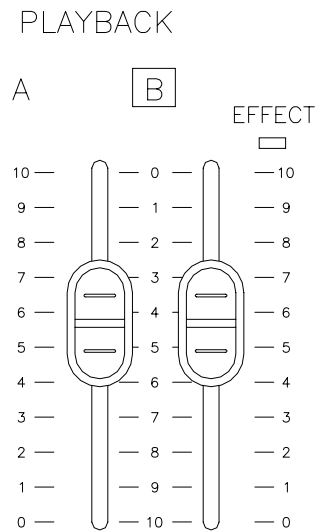

Manual Crossfades

Playback A is at full when the fader is in the UP position and at 0 when the fader is in the DOWN position. Playback B is just the opposite of playback A. (Refer to the vertical numbering beside the playbacks). This allows for proportional crossfades by moving both faders simultaneously in the same direction.

Individual channel fader control works the same in two scene mode as it does in one scene mode.

Timed Crossfades

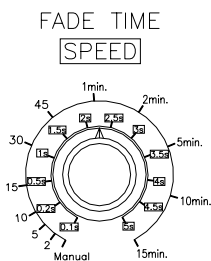

For timed crossfades – use the same procedure as the manual crossfade but with the fade timer set to the preferred fade time. The LED display will show the fade time that is set. Timed crossfades can vary from 0 (Manual) to 15 minutes.

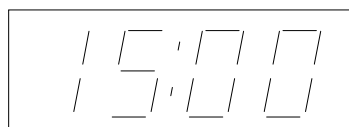

Single Scene Operation

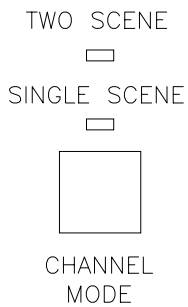

Make sure the channel mode button has the console in the single scene mode. Change the mode by pressing the channel mode button. (The corresponding light will be on)

Make sure the grand master is at full or at the desired level.

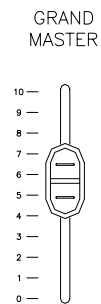

PLAYBACK
 A

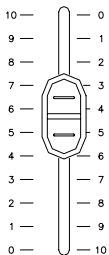

Make sure the playback A master is at full or at the desired level.

Once the above are set, simply set the faders (1 – 24) to the appropriate levels. At this point, the dimmers should correspond to the level of the faders. The fader output of the fader that is being adjusted will be shown in the LED display on a scale from 0 to 100.

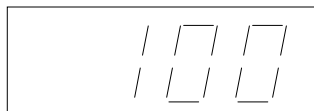
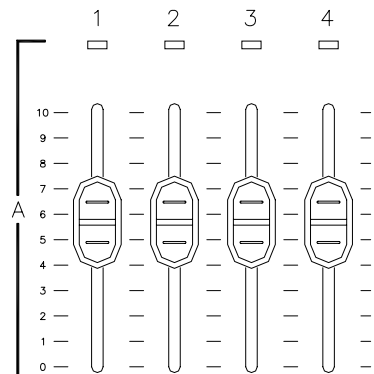

Refer to the HOLD section for crossfade information.

Hold

HOLD



In single scene mode only, using hold allows the operator to freeze all dimmer output and manually reset the levels for all 24 faders to create a different look on stage. Here's how it works...

Select current settings with channel faders. Make sure playback A master is at 10 and playback B master is at 0. (That's both playbacks in the UP position). The hold feature can only be activated and deactivated with playbacks in these positions. Press the hold key (The hold LED will now be on), move playback A's master to 0 while moving playback B's master to 10. During the crossfade, the hold LED will be flashing.

The current fader settings will now be recorded into hold's memory. (The hold LED will stop flashing but remain on indicating the activation of the hold feature. The operator is now free to reset all channel faders to the levels for the next cue. Once the channel faders are set, crossfade playback A's master back to 10 and playback B's master back to 0. (During crossfade the hold LED will flash) After a crossfade is completed, the second cue will now be outputting live. (The hold LED should still be on) Repeat the above step for the next crossfade or press hold again to release the hold function. After pressing hold, the hold LED should turn off.

Also note, that playback B is now the master for the held scene. So if playback B is moved to 0 (UP) then the held state fades out.

FADE TIME

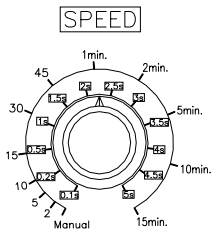

For timed crossfades – use the same procedure as the manual crossfade but with the fade timer set to the preferred fade time. The LED display will show the fade time that is set.

Remember: Hold can only be accomplished with both faders in this position.

PLAYBACK

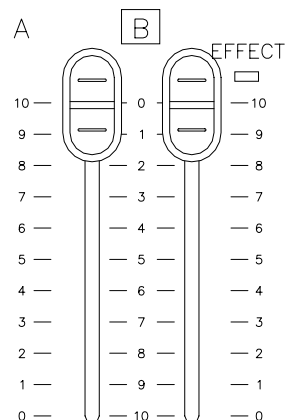

Effect – Single Scene Mode

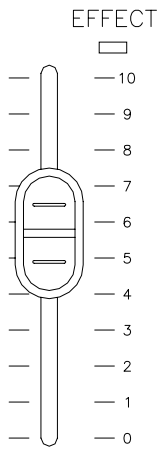

An effect is a way to get fast changing output of dimmer levels in a specific order. The effect capability of this console is limited but simple to do. The console can run one effect.

Set the console to single scene mode. Set playback A to 0 (Down) and playback B to 0 (Up). Playback B will become the effect master. (See the colored information beside the Playback B). Set current fader levels to include only the faders that will be in the effect. Set them to any level from 1 to 100.

Press one of the effect buttons (Forward, Reverse, Random, Bounce).

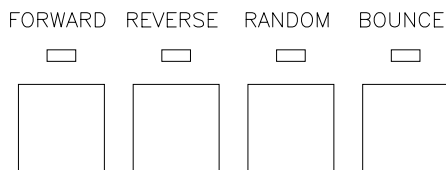

Forward will allow the active faders to chase in order from the lowest number to the highest number. (1 – 24).

Reverse will allow the active faders to chase in order from the highest number to the lowest number (24 – 1)

Random will allow the active faders to chase in a randomly generated order.

Bounce will allow the active faders to chase, first, in order from the lowest number to the highest and then, from the highest number to the lowest.

The lights will now be chasing in one of the 4 directional modes. The effect master will inhibit the levels of all effect channels. The fade time rotary becomes the SPEED dial. Set the speed of the effect appropriately. Check the LED display for your rate.

The effect can be faded in rather than the effect starting abruptly by pulling down the effect Master and fading it up at the appropriate time.

Effect – Two Scene Mode

To run the effect in two scene mode, just switch the channel mode to two scene. (Check the LED for indication of the appropriate mode setting). Now all of the fader levels from the bottom fader bank will become the faders in the effect. With both playbacks in the up position, just press any of the effect directional keys and the effect will start immediately.

Once the effect is running, adding new fader levels will add those faders into the effect.

Conclusion

This concludes the instructional manual for Strand's 100 series console.

Appendix A

Control Input

The DMX512 input will accept a multiplexed digital control signal which conforms to USITT specification DMX512 (1990). Details of this specification are available from USITT on request.

The control input is via a five-pin male XLR type connector. Pin connections are shown in Figure 9. A five-pin female XLR connector is also fitted to allow a series of SD 6 packs (or other DMX equipment) to be connected together in 'daisy chain' fashion.

It is recommended that Control connections are not plugged or unplugged when power is applied to the dimmer pack as this may cause any connected loads to flash up momentarily.

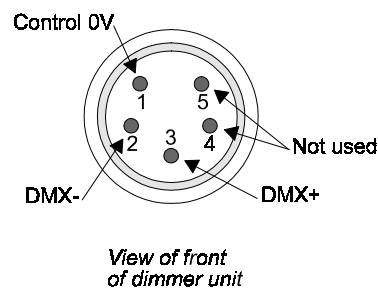

Index

B

Back Plate	6
Black Out Button	
Quick Guide	11
Bounce	15
Quick Guide <i>See</i> Effect Options Buttons	

C

Channel Faders	
Quick Guide	10
Conclusion	16
Connect DMX.....	7
Connect Power.....	7
Control Input.....	17

D

DMX output.....	7
DMX512	17

E

Effect – Single Scene Mode.....	15
Effect – Two Scene Mode.....	16
Effect Options Buttons	
Quick Guide	11

F

Face Plate	6
Fade Time / Effect Speed Dial	
Quick Guide	10
Fader Flash Buttons	
Quick Guide	10
Flash Button Mode Button	
Quick Guide	10
Forward.....	15
Quick Guide <i>See</i> Effect Options Buttons	

G

Getting Started	5
Grand Master	
Quick Guide.....	10

H

Hold	14
Hold Button	
Quick Guide.....	10

L

Layout.....	9
LED Display	
Quick Guide.....	11
LED Lights	
Quick Guide.....	11

M

Manual Crossfades	12
Mode Button	
Quick Guide.....	10

O

Operation	12
-----------------	----

P

Playback A	
Quick Guide.....	10
Playback B / Effect Master	
Quick Guide.....	10

Q

Quick Guide.....	10
------------------	----

R

Rack Mounting.....	8
Random.....	15
Quick Guide <i>See</i> Effect Options Buttons	
Reverse.....	15
Quick Guide <i>See</i> Effect Options Buttons	

S

Single Scene Operation.....	13
-----------------------------	----

T

Timed Crossfades	12
Turning the Console On	8
Two Scene Operation	12